

DEHOUST

Heat.
Energy·**Water.**

STORAGE & UTILIZATION

Steel storage tanks and pressure vessels

Buffer tanks for heat and cold

**Plastic storage tanks for water,
AdBlue[®] and concrete admixtures**

Double-walled heating oil tanks

Diesel tanks and filling stations

Cat 5 separation stations

Rainwater harvesting

Greywater recycling

Booster pump station CONNECT



DEHOUST – the company

For more than 60 years, DEHOUST, a family-owned company, has stood for the safe storage of liquid fuels. With its innovative solutions, the company has significantly influenced the technical development in this field for decades. Today, DEHOUST develops and manufactures tanks and vessels made of steel and plastic for a broad range of applications.

Each of the four production sites is focused on production and development:

Heidenau designs and manufactures buffer storage tanks for heating and cooling with volumes ranging from 2 m³ to over 150 m³, thus making an important contribution to the optimal use of renewable energies.

Tanks and pressure containers made of steel, stainless steel and complete systems for industry are developed and produced in Nienburg.

In Leimen, plastic containers from 5 to 4,000 liters and technical parts made of polyethylene (HD-PE) with weights exceeding 100 kg are produced

on blow moulding lines. User range from private homes and commercial entities through to industrial application.

Blow moulding and injection moulding are also used for external clients.

Offline fluorination is used to optimize our own products, as well as for the surface treatment of many products from customers.

The current focus of development at both the Leimen and Eitorf locations is on decentralized process water management. Innovative greywater solutions for reusing wastewater from showers and sinks actively conserve drinking water resources. With DehoustCONNECT, the company offers Internet-based solutions that are ready for the future.

DEHOUST's comprehensive expertise in all aspects of storage and warehousing makes it a sought-after partner not only for trades and industry, but also for plant engineering.

DEHOUST



Nienburg: In close cooperation with our customers we design and produce storage tanks and pressure vessels made of steel up to 200 m³



Core competence of our location **Heidenau** is planning and production of buffer tanks for hot water and chilled water.



Our service team in **Eitorf** coordinates commissioning and service for all products.



Leimen is the headquarter of Dehoust GmbH and the center of plastics processing, the production of Grey water utilization systems, rainwater systems and security separation stations.

Experience for individual solutions

DEHOUST is well-established in a wide range of industries and areas of application. From tank construction to sanitary and heating technology, from horticulture to landscaping, from AdBlue® to concrete admixtures, DEHOUST system solutions are impressive because of their quality and consistent focus on the needs of the future.

Storage tanks made of steel and stainless steel

DEHOUST produces storage tanks and pressure vessels for mineral oils and many other liquids, both underground or above ground, vertical or horizontal for volumes up to and exceeding 150 m³. Extensive in-house DIBt approvals and production in accordance with DIN and European standards provide the operator with the necessary safety. State-of-the-art surface treatment facilities ensure lasting corrosion protection – the range of applications for DEHOUST steel and stainless steel tanks is extensive.

Process water management

Separation stations, Rain Manager and greywater recycling systems conserve and protect drinking water reserves.

Storage tanks made of plastic

DEHOUST plastic tanks have been put to use successfully for decades in a wide range of industrial applications. In the food industry as well as in the chemical industry, in swimming pool construction and in the construction industry. Double-walled plastic tanks (PE Kombi and TrioSafe) have proven their performance in fuel oil storage and are now the safe solution for the storage and use of diesel fuel – also with biogenic components, lubricating and hydraulic oils and a variety of production raw materials. These systems can be used without any problems.

Fluorination

DEHOUST provides a perfect diffusion barrier with fluorination systems for its plastic tanks and also offers offline fluorination as a service for other industrial sectors. Fluorination not only traps in odors, but also creates an ideal surface for painting, gluing or printing.

Storage and warehousing

DEHOUST competence since 1958.

Ongoing development ensures progress.

Our product areas

DOUBLE-WALLED
FUEL OIL TANKS
AND DE-A-01

PLASTIC TANKS
FOR WATER,
ADBLUE®,
CONCRETE
ADMIXTURES, ETC.

BUFFERTANKS
FOR HEAT AND
COLD STORAGE

STEEL STORAGE
TANKS AND
PRESSURE
VESSELS

SEPARATION
STATIONS,
RAIN WATER
UTILIZATION,
GREYWATER
UTILIZATION

STORAGE AND
COLLECTION
TANKS



Our products

Storage tanks and pressure vessels made of steel	6
Buffer tanks from 2 m ³ up to 200 m ³	8
Steel storage tanks	16
Rainwater and fire water tanks	22
Decentralized process water management	24
Cat 5 drinking water separation stations	28
Greywater recycling	36
Rainwater booster stations and tanks	46
Plastic storage tanks PE-DF and AQF	54
Single-walled and double-walled plastic tanks with approval (DIBt)	62
Storage tanks for AdBlue® and concrete admixtures	64
Double walled tanks PE Kombi and TrioSafe	66

Storage tanks and pressure vessels made of steel

The plants in Nienburg and Heidenau specialize in steel container construction – but the two sites have different focuses

Cylindrical storage tanks made of steel in accordance with EN12285 are a central part of our manufacturing program. Tanks for underground and above-ground storage of liquids that are hazardous to water have been continuously developed and improved. General building inspectorate approvals from German Institute for Construction Technology DIBt extend and simplify the possible uses of steel tanks.

Buffer tanks are becoming increasingly important in the energy transition. We manufacture these pressure vessels in a range of designs, each with factory-made thermal insulation. Operating pressures can be selected on a specific project basis and are configured as standard for 3 bar, 6 bar and 10 bar.

We project and design customer-specific storage vessels and pressure vessels in close coordination with our partners and complement them with heaters, measurement and control technology as well as a number of other accessories.

We manufacture in accordance with national and international norms and quality standards. Our plants, for example, are certified in accordance with the regulations for pressure equipment AD-2000 Merkblatt HP0 and recognized as a welding manufacturer in accordance with the guidelines of DIN EN ISO 3834-2. We were also certified in accordance with the regulations of DIN EN 1090-2 for steel structures. We use only TÜV-certified welders in all standard procedures.

Our products:

- ▶ **Buffer tanks for heat and cold storage**
- ▶ **Storage tanks**
- ▶ **Rainwater storage tanks**
- ▶ **Fire water tanks**



Heat.
Energy. Water.

STORAGE & UTILIZATION

1

Buffer tanks for heat and cold storage

Buffer storage for heating and cooling is a key element of the energy transition. Renewable energies and waste heat from industry, biomass and CHP plants are not always there when they are needed as heat. Large-volume buffer storage helps bridge these periods.



Dehoust buffer tanks

- ▶ Correspond to Article 4 (3) of the Pressure Equipment Directive 2014/68/EU
- ▶ Are designed in accordance with AD 2000
- ▶ Proof of stability and verifiable structural analysis in accordance with AD 2000 for submission to the approval authorities upon request
- ▶ Earthquake and wind loads are taken into consideration in the offer
- ▶ Acceptance by a certified plant inspector

... the coating makes the difference

Individually designed curved pipes or distribution pipes create the basis for optimal coating in all types of storage tanks.

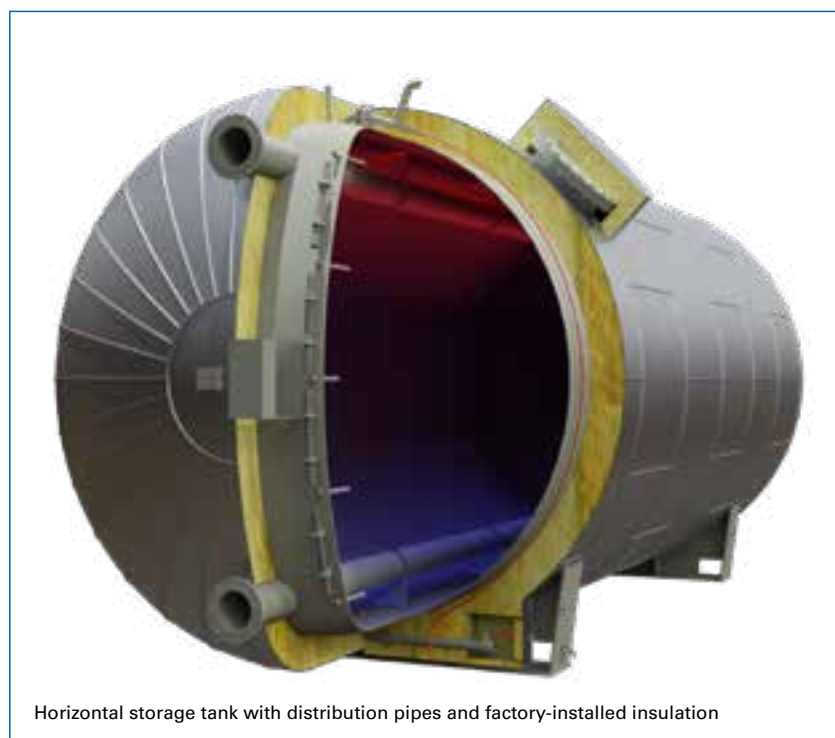

Horizontal storage tank with distribution pipes and factory-installed insulation

... Control is better

We deliver temperature measurement technology adapted to the plant, from sensors to transmitters factory-installed. For easy integration into the building technology system, ending in a terminal box that is mounted ready for connection.

In addition to our standard, consisting of Pt100 cable sensors in 3-wire circuit, we also offer individual solutions depending on customer requirements.

... so the buffer tank can maintain its shape

Factory-installed vacuum breakers prevent improper negative pressure in the accumulator and reduce the installation work on site.

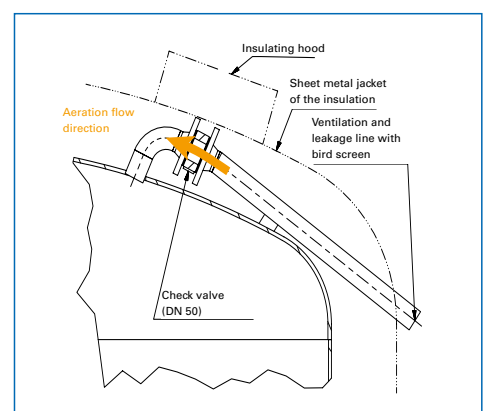

... from 2 m³ up to 200 m³

... so that no energy is lost

Our high-quality thermal insulation with very low heat loss and, in the case of the cold accumulator, the diffusion-tight cold insulation ensure the energy is kept in the accumulator.

Our standard range at a glance

- ▶ Above-ground heat storage tanks from 10 m³ to 152 m³
- ▶ Vertical above-ground heat buffer tanks 2 m³ to 10 m³
- ▶ Horizontal above-ground buffer storage tanks up to 150 m³
- ▶ Underground buffer tanks 2 m³ to 100 m³
- ▶ Vertical cold storage from 2 m³ to 152 m³



Heating buffer tanks

Vertical above-ground heating buffer tank, 2,000 to 10,000 liters, operating pressure 4 bar

without insulation					Insulation 100 mm	
Article no.	Nominal capacity liters	Diameter mm	Height approx. mm	Weight kg	Article no.	Weight kg
176905	2,050	1,200	2,250	440	170904	40
176910	2,600	1,200	2,750	500	170909	45
176915	3,150	1,200	3,250	565	170914	50
176920	3,700	1,200	3,750	620	170919	60
176925	4,250	1,200	4,250	685	170924	65
176930	4,800	1,200	4,750	745	170929	70
176960	5,150	1,400	3,850	795	170959	70
176965	5,950	1,400	4,350	865	170964	75
176970	6,700	1,400	4,850	935	170969	85
176975	7,450	1,400	5,350	1,005	170974	90
176980	8,200	1,400	5,850	1,075	170979	100
176985	8,950	1,400	6,350	1,150	170984	105
176990	9,750	1,400	6,850	1,225	170989	115

The tanks are equipped as standard with 6 connections for flow and return.

The insulation consists of 100 mm polyester fleece, plastic laminated.

Above-ground heat storage tanks operating pressure 6 bar

without insulation					Insulation 200 mm	
Article no.	Nominal capacity liters	Diameter mm	Height approx. mm	Weight kg	Article no.	Weight kg
176020	10,000	1,600	6,490	1,750	170020	550
176065	11,000	2,000	4,630	1,900	170065	500
176085	17,000	2,000	6,630	2,450	170085	700
176165	22,000	2,500	5,790	3,250	170165	800
176175	32,000	2,500	7,790	4,000	170175	1,050
176195	42,000	2,500	9,790	4,800	170195	1,300
176215	52,000	2,500	11,790	5,600	170215	1,550
176240	44,000	2,900	7,920	5,100	170240	1,300
176245	51,000	2,900	8,920	5,500	170245	1,450
176250	57,000	2,900	9,920	5,950	170250	1,600
176260	70,000	2,900	11,920	7,000	170260	1,900
176270	84,000	2,900	13,940	8,200	170270	2,200
176280	96,000	2,900	15,940	9,350	170280	2,500
176385	102,000	3,200	14,040	11,400	170385	2,450
176395	118,000	3,200	16,040	12,700	170395	2,800
176460	123,000	3,500	14,130	12,650	170460	2,700
176475	152,000	3,500	17,130	15,100	170475	3,250

Heating buffer tanks for various operating pressures and diameters, thicker insulation and color changes of the aluminum outer shell, as well as the number of hydraulic connections and sensor sleeves are all available upon request.

Buffer storage tanks for local and district heating networks, industrial and commercial applications – a key component of the energy transition for operating pressures up to 10 bar

The use of biomass, CHP plants and many industrial plants generate heat as a waste product. Usually also with high temperatures, so that storing this energy in large-volume storage tanks is possible without any problems.

We manufacture these storage tanks in modular systems for indoor and outdoor installation. With factory-installed insulation, the operator gets an energy storage system that meets all legal and technical requirements. A broad range of color-coated plain sheets also makes it easy to match the architectural environment.



Heat storage tanks for indoor and outdoor installation



Heating buffer tanks

Horizontal buffer tanks

Temperature layering for horizontal storage tanks is of course more problematic to achieve due to the limited height.

The distribution pipes we have calculated and used for injection and extraction have proven in many projects that layering and thus optimum operation is also possible here.

The factory-installed thermal insulation keeps the energy in the tank.



Buffer storage tank in horizontal design for above-ground installation



Horizontal above-ground heat storage tanks operating pressure 6 bar

Article no.	without insulation				Insulation 200 mm	
	Nominal capacity liters	Diameter mm	Length approx. mm	Weight kg	Article no.	Weight kg
117005	10,000	1,600	5,700	1,900	170020	550
117017	17,000	2,000	5,870	2,550	170085	700
117035	32,000	2,500	7,070	4,300	170175	1,050
117055	52,000	2,500	11,070	6,000	170215	1,550
117065	44,000	2,900	7,220	5,300	170240	1,250
117085	57,000	2,900	9,220	6,200	170250	1,600
117115	83,000	2,900	13,220	8,250	170269	2,200
117125	97,000	2,900	15,220	9,200	170285	2,500
117135	102,000	3,200	13,360	11,550	170385	2,450
117165	152,000	3,500	16,480	15,300	170475	3,250

Please inquire about heating buffer tanks for various operating pressures and diameters, thicker insulation and color changes of the aluminum outer shell, as well as the number of hydraulic connections and sensor sleeves.

Buffer storage tank in horizontal design for underground installation – vertical and horizontal



Horizontal underground heat storage tanks operating pressure 6 bar

Including insulation 200 mm				
Article no.	Nominal capacity liters	Diameter mm	Length approx. mm	Weight kg
112017	10,000	2,400	4,000	2,650
112037	20,000	2,400	7,300	4,400
112047	30,000	2,400	10,600	6,050
112057	40,000	2,900	9,100	6,400
112067	50,000	2,900	11,100	7,650
112077	60,000	3,300	10,100	9,400
112087	80,000	3,300	13,200	11,950
112097	100,000	3,300	16,200	14,400

Horizontal underground heat storage tanks

With a GRP outer shell and PUR foam insulation, heat storage tanks are optimally insulated against heat loss and moisture. The result is highly efficient heat storage tanks up to over 100,000 liters in volume, which can absorb excess heat and thus store the energy efficiently. **Double insulation, maximum efficiency!**

Vertical underground heat storage tanks operating pressure 3 bar

Including insulation 200 mm				
Article no.	Nominal capacity liters	Diameter mm	Length approx. mm	Weight kg
112206	2,050	1,700	2,500	650
112212	3,100	1,700	3,300	850
112222	6,300	2,200	3,500	1,250
112232	9,800	2,700	3,400	1,600
112242	14,200	3,200	3,500	2,500

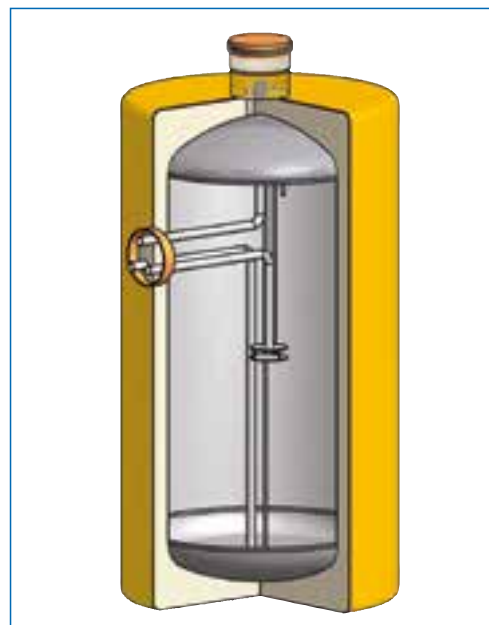

Storage of chilled water

Increase energy efficiency with cold storage tanks

Cooling is required for air conditioning in buildings and for many industrial processes. Cooling needs are often quite variable and therefore place substantial demands on the installed cooling systems. Optimally designed cold storage tanks can extend the running time of cooling systems and thus increase energy efficiency.

With Dehoust cold storage tanks, the electrical load peak is reduced, the security of supply is increased and the degree of utilization is improved.

Dehoust cold storage tanks are adapted to plant requirements. The storage tanks are prepared for the application of diffusion-tight cold insulation. We recommend industrially-installed insulation with a jacket of aluminum smooth sheeting. The storage tanks are designed for operation with chilled water up to 6 bar and max. 50 °C.

The storage tanks are manufactured with a manhole DN 500. The hydraulic connections and sensor sleeves are adapted to the specific project.



Above-ground cold storage tanks 10 m³ to 152 m³ operating pressure 6 bar

Article no.	without insulation				Insulation 32 mm	
	Nominal capacity liters	Diameter mm	Height approx. mm	Weight tank kg	Article no.	Weight kg
179020	10,000	1,600	6,390	1,700	171020	150
179065	11,000	2,000	4,530	1,850	171065	150
179085	17,000	2,000	6,530	2,400	171085	200
179165	22,000	2,500	5,690	2,950	171165	200
179175	32,000	2,500	7,690	3,600	171175	300
179195	42,000	2,500	9,690	4,300	171195	350
179215	52,000	2,500	11,690	4,950	171215	450
179240	44,000	2,900	7,820	5,050	171240	400
179245	51,000	2,900	8,820	5,500	171245	450
179250	57,000	2,900	9,820	5,950	171250	500
179260	70,000	2,900	11,820	6,950	171260	550
179270	84,000	2,900	13,840	8,200	171270	650
179285	97,000	2,900	15,840	9,050	171285	750
179385	102,000	3,200	13,940	11,400	171385	700
179395	118,000	3,200	15,940	12,700	171395	800
179460	123,000	3,500	14,030	12,650	171460	800
179475	152,000	3,500	17,030	15,100	171475	950



In data centers, heat is generated and cooling is a necessity. Buffer storage tanks are used for the effective storage and provision of heat and cold.

Above-ground cold storage tanks 2 m³ to 10 m³, operating pressure 6 bar

without insulation				
Article no.	Nominal capacity liters	Diameter mm	Height approx. mm	Weight tank kg
179905	2,050	1,200	2,250	440
179910	2,600	1,200	2,750	500
179915	3,150	1,200	3,250	565
179920	3,700	1,200	3,750	620
179925	4,250	1,200	4,250	685
179930	4,800	1,200	4,750	745
179960	5,150	1,400	3,850	795
179965	5,950	1,400	4,350	865
179970	6,700	1,400	4,850	935
179975	7,450	1,400	5,350	1,005
179980	8,200	1,400	5,850	1,075
179985	8,950	1,400	6,350	1,150
179990	9,750	1,400	6,850	1,225



The cold storage tanks in this series are manufactured without a manhole and are prepared for the installation of cold insulation.

Steel storage tanks

We manufacture pressureless storage tanks in accordance with DIN EN 12285, our own general construction approvals/general construction type approvals (DIBt) and according to customer requirements.

The tanks are supplied with test marks or CE marks and also specific acceptance certificates.

Find out about our standard storage tanks:

- page 21:** Above-ground storage tanks in accordance with DIN EN 12285-2
- page 22:** Double-walled underground storage tanks, accessible, DIN EN 12285-1
- page 26:** Vertical storage tanks – single and double-walled with general technical DIBt approval
- page 27:** Double-walled tanks with bottom outlet
- page 28:** Rainwater and fire water tank



For filling stations we supply containers for the storage of various fuels and for the NO_x reducing agent AdBlue®.



Fire water storage and rainwater utilization can be combined with our tanks.



Above-ground tank systems in accordance with DIN EN 122852, class B, tank type D for heating oil and diesel fuel – complete with saddle feet, fittings and leak sensor

Double-walled cylindrical storage tanks made of steel with RAL-GZ 998 seal of quality for above-ground storage of heating oil and diesel fuel.

Container inside raw, outside blasted, primed and painted in a defined RAL color. Double jacket monitored with control liquid.

Complete tank system equipped with:

- ▶ Dome DN 600
- ▶ optical leakage indicator including test cock and control liquid for refilling
- ▶ Welded saddle feet
- ▶ Ladder with pedestal, galvanized
- ▶ Tank fitting consisting of:
 - Filling tube 2"
 - Suction combination up to max 150 l/h for fuel oil or 1 1/4" suction pipe for diesel fuel
 - Venting connection with 1 1/2" cap
 - Dipstick 1" with feeler rod
- ▶ Limit transmitter

For tank diameters 2500 mm and larger, the tank fittings, the limit transmitter and the leakage indicator are supplied with a 10 l container of control liquid and must be screwed to the tank on site.



Diesel tank with platform and suction line

Article no.	Nominal content l	Diameter mm	Length mm	Dimensions saddle feet		Weight without attachments approx. kg
				Distance mm	Width mm	
100205	5,000	1,600	2,750	1,770	300	1,265
100210	7,000	1,600	3,750	2,770	300	1,580
100215	10,000	1,600	5,350	4,290	300	2,105
100220	13,000	1,600	6,950	5,625	475	2,650
100225	16,000	1,600	8,530	7,135	475	3,170
100230	20,000	2,000	6,870	5,395	550	3,860
100235	25,000	2,000	8,420	7,005	550	4,575
100240	30,000	2,000	9,970	8,615	550	5,280
100245	40,000	2,500	8,710	6,760	900	7,640
100250	50,000	2,500	10,680	8,820	900	8,990
100255	60,000	2,500	12,650	10,880	900	10,335
100260	80,000	2,900	12,800	10,295	1,300	15,060
100265	100,000	2,900	15,930	13,360	1,300	18,030

Additional equipment for diesel tank systems

Article no.	Description
900030	Column pedestal for dispenser
900081	Filling tube 3" instead of 2"

Suction line 1 1/4" or 2" with siphon protection and stopcock pulled down to the column pedestal as well as dispenser (without assembly) at extra charge.

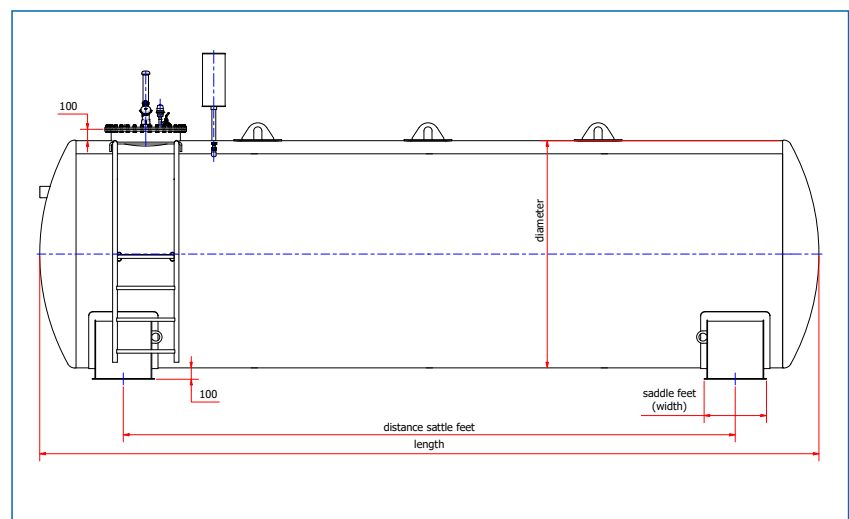

Steel storage tanks

Underground steel tanks in accordance with EN 12285



Technology on the outside, future on the inside

Cylindrical storage tanks made of steel in accordance with EN 12285 are double-walled and approved for the storage of many different media. The standards include extensive media lists.

Inner and outer tanks are made of high-quality steel – upon request also with additional internal corrosion protection.

The containers are protected on the outside by plastic insulation (Endoprene) in accordance with EN 12285-1.

The monitoring space is monitored with a vacuum leak detector. Pressure monitoring is also possible upon request. For special requirements, the tanks can be made of stainless steel.

Prefabricated manhole height adjustable, cover walkable, galvanized

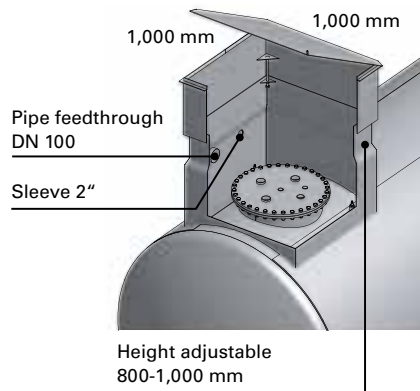

Prefabricated manholes for steel tanks

Liquid-tight welded-on manhole collars or base parts for prefabricated manholes are mandatory under water law, and are included in the scope of delivery for complete tanks. They can be combined with any underground storage tank.



Storage of the tanks

Article no.	Description
900140	Shaft 600 mm high, not height-adjustable, cover can be walked on
900144	Shaft height adjustable 800-1,000 mm, cover can be walked on

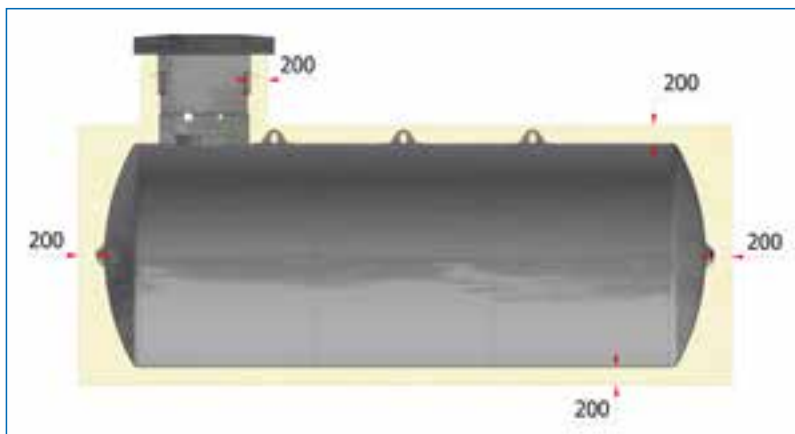

The dimensions of the pits must be such that the tanks are surrounded by at least 200 mm of sand with a grain size of < 2 mm. Depth depends on the selected prefabricated manhole. The base is to be constructed in such a way that the tank is stored with a gradient of approx. 1% towards the end of the dome (largely horizontal in the case of multi-chamber tanks). If groundwater occurs or in flooded areas, the tank must be secured accordingly.

As an additional service, we offer the required insulation test and storage monitoring. A crane for laying the tank and sufficient backfill material must be provided by the customer.

Double-walled steel tanks in accordance with EN 122851

Article no.	Nominal capacity liters	Tank diameter mm	Length mm	Weight kg
100510	5,000	1,600	2,750	1,170
100520	7,000	1,600	3,750	1,490
100530	10,000	1,600	5,350	2,015
100540	13,000	1,600	6,950	2,510
100550	16,000	1,600	8,530	3,000
100531	10,000	2,000	3,770	2,070
100541	13,000	2,000	4,550	2,550
100551	16,000	2,000	5,520	3,190
100560	20,000	2,000	6,870	3,610
100570	25,000	2,000	8,420	4,335
100580	30,000	2,000	9,970	5,170
100561	20,000	2,500	4,570	4,020
100571	25,000	2,500	5,580	4,800
100581	30,000	2,500	6,740	5,410
100590	40,000	2,500	8,710	6,840
100600	50,000	2,500	10,680	8,250
100610	60,000	2,500	12,650	9,810
100591	40,000	2,900	6,680	7,370
100601	50,000	2,900	8,170	9,040
100749	60,000	2,900	9,630	10,410
100620	80,000	2,900	12,800	13,670
100625	100,000	2,900	15,930	16,586

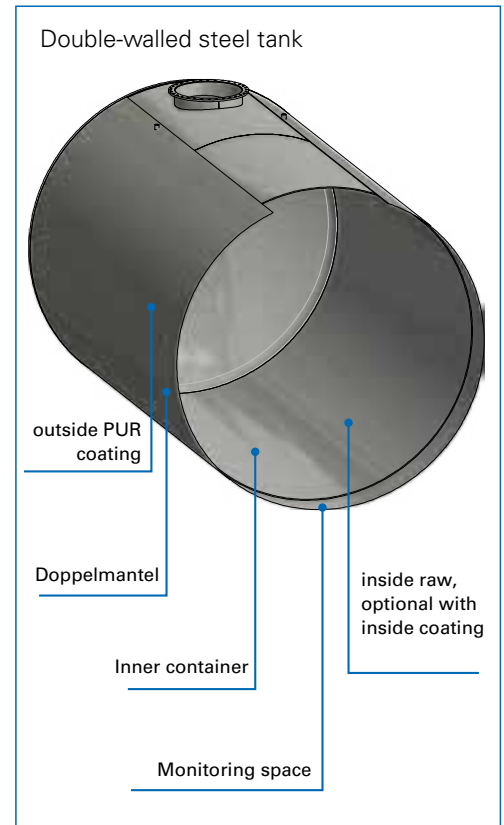

Edelstahlbehälter für AdBlue®

For safe storage of the high-purity aqueous urea solution "AdBlue®", Dehoust offers the combination of stainless steel (inner tank) and standard steel (outer tank). This tank, known as a "black and white tank", is a low-maintenance solution compared to a double-walled steel tank with internal coating; regular inspection of the internal coating is not required. 6608/2 or EN 12285 explicitly provides for this combination of materials.

The seal of compliance eliminates the need for costly suitability certificates.

Examples for AdBlue® Containers:

Article no.	Nominal capacity liters	Diameter mm	Length mm	Weight kg
940100	5.000	1.600	2.750	1.170
940105	7.000	1.600	3.750	1.490
940110	10.000	1.600	5.350	2.015
940115	20.000	2.000	6.870	3.610



**GREATER SAFETY AND CLARITY
THROUGH DIBt APPROVAL**



The described material combination up to stainless steel grade 1.4571 is also suitable and approved for the storage of other water-endangering, flammable and non-flammable liquids in accordance with the positive liquid list of EN 12285-1, Appendix B.

Storage tanks

Vertical steel tanks with general technical DIBt approval



Above-ground vertical tanks offer the advantage of placing large storage volumes in a small footprint.

Special designs and variants within the diameters and volumes are possible. Depending on your requirements, we supply filling and suction lines, platforms with access ladders as well as heaters and safety fittings. Additional corrosion protection inside and outside is available upon request.

Vertical storage tanks made of steel or stainless steel

- ▶ For unpressurized operation
- ▶ Vertical on 4 tube feet
- ▶ Approved for the storage of liquids hazardous to water in accordance with the positive list of DIN EN 12285-1, Appendix B, media density up to 1.6 kg/dm³
- ▶ The tanks are designed for indoor and outdoor installation up to and including wind and snow load zone 2 in accordance with DIN 1055

Vertical single-walled tanks

Z-38.11-241 and Z-38.11-323

Article no.	Nominal capacity liters	Diameter mm	Height incl. feet mm	Weight kg
104010	5,000	1,600	3,410	980
104020	7,000	1,600	4,400	1,180
104030	10,000	1,600	6,000	1,520
104040	13,000	1,600	7,590	1,940
104050	16,000	1,600	9,190	2,260
104051	16,000	2,000	6,010	2,290
104060	20,000	2,000	7,570	2,910
104070	25,000	2,000	9,120	3,410
104080	30,000	2,000	10,670	3,880
104081	31,000	2,500	7,450	4,000
104090	42,000	2,500	9,740	5,450
104100	52,000	2,500	11,710	6,350
104110	61,000	2,500	13,680	7,250
104091	45,000	2,900	8,010	4,800
104101	58,000	2,900	10,010	6,140
104120	78,000	2,900	13,010	7,460
104130	98,000	2,900	16,010	8,800
104126	85,000	3,200	11,810	9,850
104140	103,000	3,500	11,910	11,230

Vertical double-walled tanks

Z-38.12-260 and Z-38.12-270

Article no.	Nominal capacity liters	Diameter mm	Height incl. feet mm	Weight kg
104015	5,000	1,600	3,410	1,450
104025	7,000	1,600	4,400	1,770
104035	10,000	1,600	6,000	2,290
104045	13,000	1,600	7,590	2,960
104055	16,000	1,600	9,190	3,490
104056	16,000	2,000	6,010	3,340
104065	20,000	2,000	7,570	4,170
104075	25,000	2,000	9,120	4,920
104085	30,000	2,000	10,670	5,630
104086	31,000	2,500	7,450	5,940
104092	42,000	2,500	9,740	8,160
104105	52,000	2,500	11,710	9,550
104111	61,000	2,500	13,680	10,940
104096	45,000	2,900	8,010	7,420
104106	58,000	2,900	10,010	9,490
104125	78,000	2,900	13,010	11,710
104136	98,000	2,900	16,010	13,920



All dimensions are subject to change, in case of order we will provide a detailed drawing.

Give us a call – our project engineers will be happy to give you any advice you need at 0049 5021-970350

... made of steel and stainless steel

Double-walled tanks with bottom outlet



General technical approval:

No. Z-38.12-147

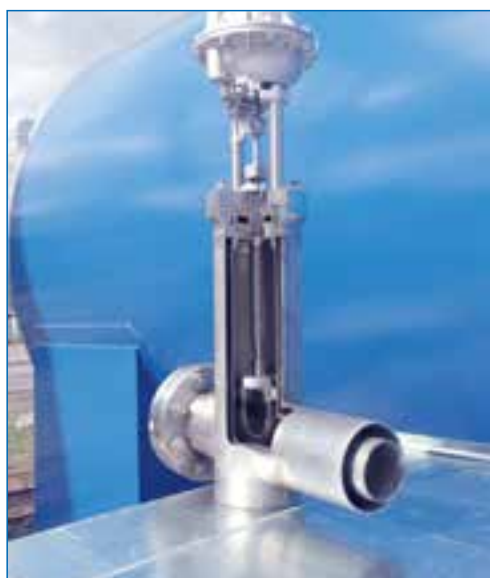

Double safety made of steel

Cylindrical, double-walled storage tanks (vertical or horizontal) with a lower, leak-monitored removal system.

With the general technical approval of the DIBt Z-38.12-147, a leakage-monitored extraction device for double-walled

storage tanks approved under building and water laws. This simplifies the connection of double-walled steel tanks in accordance with EN 12285-2 or DIBt approval Z-38.12-260 and Z-38.12-270, as complex extraction systems via the tank apex are no longer required.

Rainwater storage tanks



Rainwater storage tanks made of steel

The single-cell storage tanks made of steel are suitable for the storage and retention of large quantities of rainwater. These are similar to the tanks built in accordance with EN 12285-1 for the accessible area and in accordance with DIBt approval Z-38.13-331 for the trafficable area and are coated on the inside with a high-quality plastic full lining for rainwater up to 35 °C.

On the outside, the containers are finished with plastic insulation (Endoprene) in accordance with EN 12285-1, providing all-round durable protection.



Standard dimensions for single-walled rainwater and fire water tanks

Article no.	Nominal capacity l	Diameter mm	Length mm	Weight kg
116000	20,000	2,000	6,870	2,480
116010	25,000	2,000	8,420	2,970
116020	30,000	2,000	9,970	3,580
116025	30,000	2,500	6,740	3,750
116030	40,000	2,500	8,710	4,490
116040	50,000	2,500	10,680	5,450
116055	60,000	2,900	9,630	7,420
116060	80,000	2,900	12,800	9,550
116070	100,000	2,900	15,930	11,820



Rainwater storage tank with additional prefabricated manhole

Prefabricated manholes for rainwater storage and fire water tanks

Article no.	Description
900140	Shaft 600 mm high, not height-adjustable, cover can be walked on
900144	Shaft height adjustable 800-1,000 mm, cover can be walked on
900150	Shaft height adjustable 800-1,000 mm, trafficable cover
900055	Shaft height adjustable 800-1,000 mm, trafficable cover
900038	Manhole collar in accordance with DIN 6627, 200 mm high, 1,060 x 1,060 mm



With a feeder pump, the rainwater storage tank or fire water tank feeds a hybrid system or separation station, thus ensuring an inexpensive and reliable supply of process water (see page 49).

Fire water tanks



Ready for anything that might happen

Dehoust fire water tanks are made of high quality steel and are protected against corrosion inside and out. They ensure the supply of water to fight fires and can be supplied with rainwater and/or city water. In addition to DIN 14230, both DIN EN 1717 and the relevant regulations (e.g. Drinking Water Ordinance) must be observed. The tanks can also be used as retention tanks (please coordinate with fire protection). Different suction connections in accordance with DIN 14244 are available, overflow connections and end connections are adjusted depending on the relevant requirements.

Design example

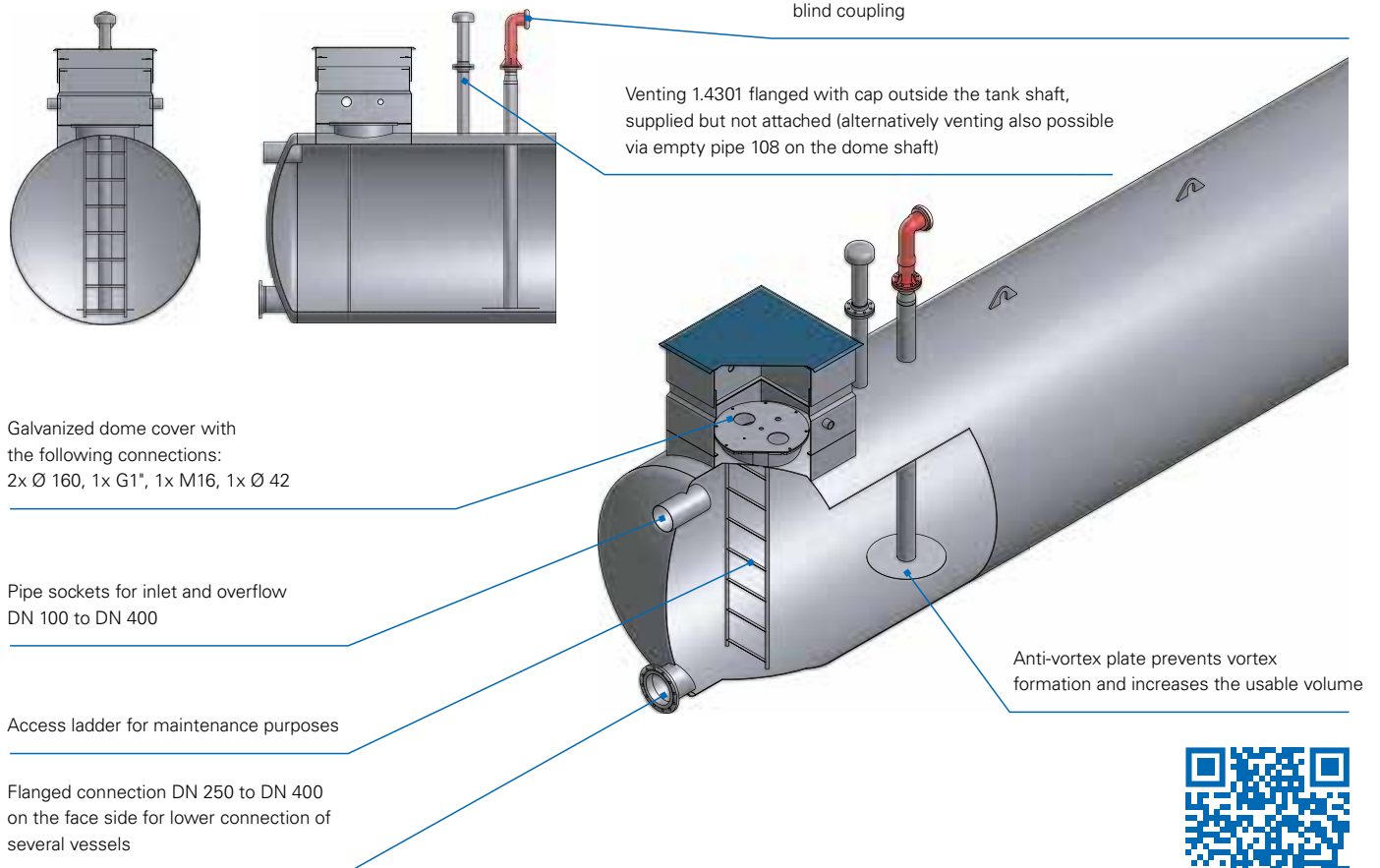

Decentralized process water management

The careful use of drinking water as a foodstuff secures the supply of water for future generations.

The use of rainwater and treated greywater instead of valuable drinking water conserves resources, but also places high demands on operating technology.

Recontamination of the public drinking water network is a recurring concern for water utilities. Despite the clear regulations that are laid out in EN 1717, the system separation of drinking water and process water is often not carried out consistently. With the drinking water separation station Cat 5, it is easy to meet the strict requirements of the drinking water ordinance. The connect control monitors and regulates the operation, larger storage tanks from the plastic tank program ensure the operating water supply, even when the drinking water supply fluctuates.

The combination of the Rain Manager and drinking water separation stations with the extensive Dehoust tank program guarantees a tailor-made solution for nearly any requirement, up to combined rain and fire water storage tanks.

In greywater utilization, we rely on ultrafiltration, both with submerged filters and with dry filters. The new MB series guarantees maximum efficiency with high operational reliability and low maintenance costs. It also includes direct access to the system through DehoustCONNECT and in combination with our separation stations or Cat 5 Break tanks in accordance with DIN EN 1717.

Our focus topics:

- ▶ **We bring water to the Internet**
- ▶ **Separation stations**
- ▶ **Greywater**
- ▶ **Rainwater**



Heat.
Energy·Water.

STORAGE & UTILIZATION

2

DEHOUSTCONNECT

Keep an eye on your process water system worldwide



Industry 4.0



DehoustCONNECT is the basis for controlling and monitoring plants over the Internet:

- ▶ Double pumps
- ▶ Safety separation stations
- ▶ Rainwater hybrid systems
- ▶ Greywater utilization systems

Smarthome for your water management



Industry 4.0

SIMPLE AND SAFE INSTALLATION

With DehoustCONNECT, the service water system is connected through secure internet to the operator's smartphone, the installer's tablet and/ or PC, and to the Dehoust service department. The operating status of the system can thus be seen at all times. Operational irregularities can be communicated to authorized persons or companies over the secure Dehoust server.

CONNECT control always has its full functionality even when it is not connected to the Internet.

Installation is extremely simple with the LAN or WLAN network and the Dehoust app. This is where Dehoust's commissioning service provides you with all the help you need.

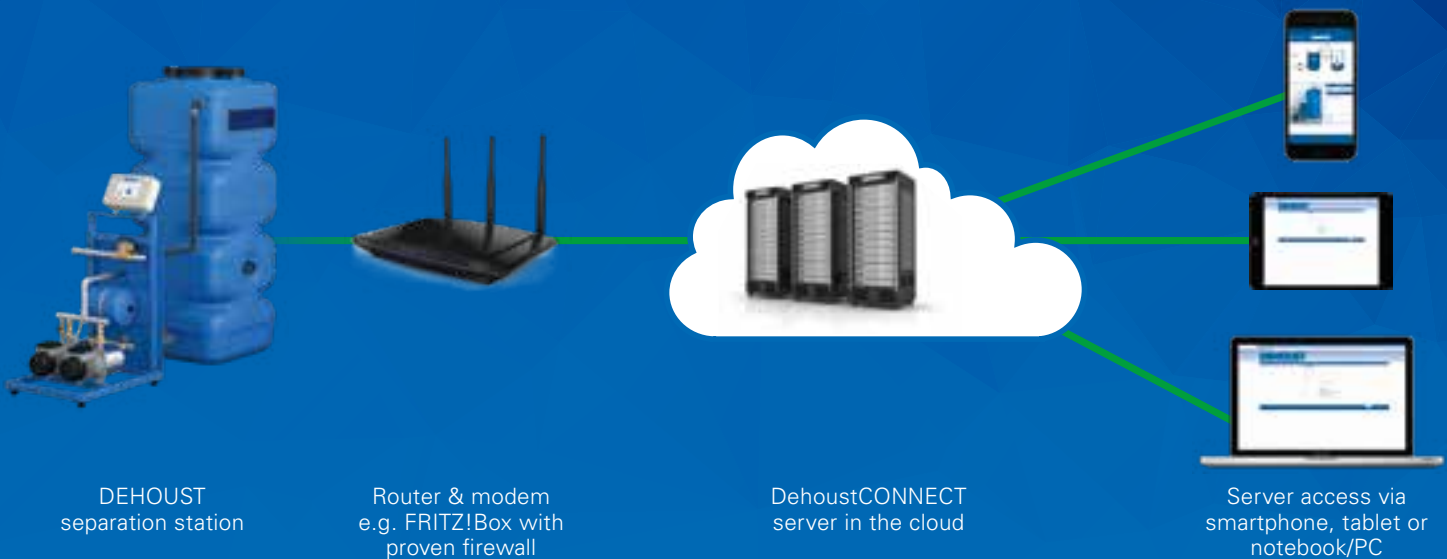

SERVICE WATER SYSTEMS ALWAYS VISIBLE WITH DEHOUSTCONNECT

The economic basis for pressure boosting, safety separation stations and rainwater utilization

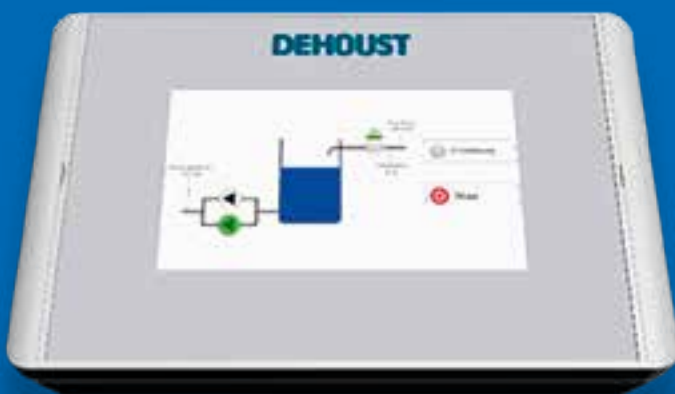

- ▶ Live monitoring
- ▶ Logs
- ▶ Remote diagnostics and maintenance
- ▶ Alarm and operating status
- ▶ Update over the Internet



DehoustCONNECT
We protect drinking water

For the safe separation of ...



Dehoust separation stations in accordance with DIN EN 1717 for process water of liquid category 5 ensure maximum safety.

The systems developed by Dehoust offer the highest level of protection for separate drinking and process water systems, including systems with different requirements, thus making sure that you, as the operator and installer, are on the safe side.

System separation for process water is a professional matter – that is why you should put planning and execution in the hands of specialized companies and leave nothing to chance when it comes to drinking water protection.

Examples for a compulsory free outlet

- ▶ Washing fruit and vegetables (food establishments)
- ▶ Pre-washing and washing of dishes and kitchen utensils
- ▶ Wastewater
- ▶ Water from body cleaning
- ▶ Water for animal drinking troughs
- ▶ Swimming pool water
- ▶ Washing machine water
- ▶ Toilet water
- ▶ Cleaning in slaughterhouses
- ▶ Cooling system supply
- ▶ Underground sprinkler system

DIN EN 13077

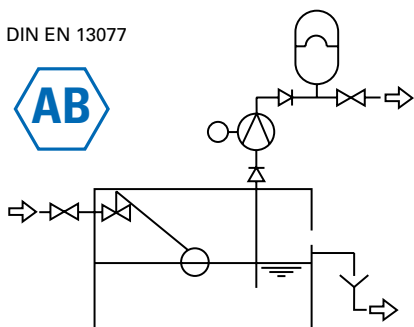

... process water and drinking water

Drinking water separation stations for any capacity and purpose from 2 m³/hour to over 20 m³/hour also as double-pump systems.



Wall-mounted separation station from 2 to 3.2 m³/hour



floor-standing separation station up to 5 m³/hour



floor-standing separation station up to 7 m³/hour



Compact CONNECT drinking water separation station with double pump



CONNECT separation station with large feed tank and double pump



Break tank Cat 5 EN 1717 with emergency overflow type AB in accordance with DIN EN 13077



THE RIGHT SOLUTION FOR
WHATEVER YOU NEED.

Wall mounted drinking water separation stations

For the safe separation of process water and drinking water in private and commercial installations for flow rates from 2 to more than 3 m³/hour*.

The safety separation station is supplied ready for connection in 2 power sizes.

The float valve automatically ensures refeeding into the integrated storage tank – the achievable continuous output depends essentially on the drinking water supply.

The free outlet type AB in accordance with DIN EN 13077 has been tested by TZW Karlsruhe and both devices have the DVGW CERT label.

Pumps specially developed for process water supply, together with the robust flow monitor, ensure a reliable supply of process water to users.

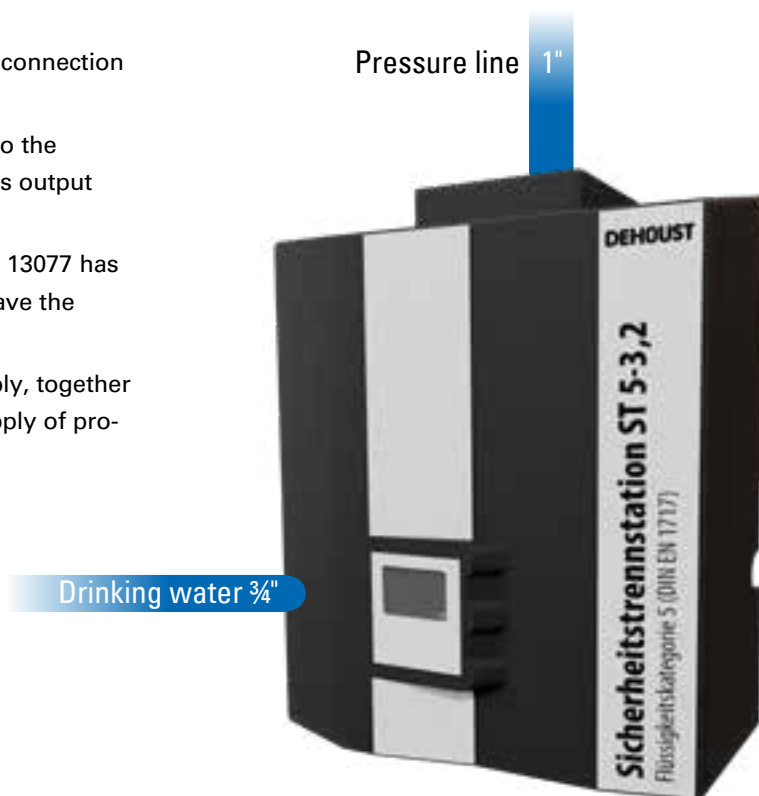

Safety separation stations	ST 5-2.7	ST 5-3.2
Article no.	812307	813092
max. flow rate in m ³ /hour*	2.7	3.2
max. conveying height in m	44	52
Switch-on pressure in bar	2.4	1.5
Supply voltage	230 V / 50 Hz / 16 A	230 V / 50 Hz / 16 A
Total height in mm	580	700
Width in mm	380	595
Depth in mm	295	305
Empty weight in kg	18	25

*The conveying volume depends on the drinking water supply, in case of weak line pressure we recommend devices with a larger supply tank.

No chance of recontamination



Interior view ST 5-2.7



ST 5-2.7



ST 5-3.2

Sprinkler systems and underground piping must also be separated by “free outlet” in private areas.

**THE STRICT RULES OF DIN 1988-100 APPLY
IN CONJUNCTION WITH DIN EN 1717,
ALSO IN THE PRIVATE AREA**

For more information, scan the QR code or enter the item number in the dehoust.com search box.

Separation station ST 5 floor-standing

With large storage tanks to compensate for fluctuations in the drinking water network for capacities from 4 to over 7 m³/hour.*

High volume and space-saving design are what set this separation station apart.

The arrangement of the proven float valve on type ST 5-4.3 or the water-cooled magnet valve on type ST 5-7.2 prevents splashing water at the drinking water inlet even with high feed-in volumes. Any water escaping through the free outlet type AB in accordance with DIN EN 13077 is drained off in a controlled manner. The separation stations are nevertheless placed only in rooms with floor drain.

Submerged pumps ensure extremely quiet running and the adjustable flow monitor ensures adapted operation.



ST 5-4.3 floor-standing, interior view

Safety separation stations	ST 5-4.3	ST 5-7.2
Article no.	814261	814265
max. flow rate in m ³ /hour*	5	7.2
max. conveying height in m	56	68
Switch-on pressure in bar	zw. 0.5 und 4 einstellbar	zw. 0.5 und 4 einstellbar
Supply voltage	230 V / 50 Hz / 16 A	230 V / 50 Hz / 16 A
Useful volume tank in liters	110	110
Total height in mm	1.010	1.105
Width in mm	300	300
Depth in mm	820	820
Empty weight in kg	36	36

*The conveying volume depends on the drinking water supply, in case of weak line pressure we recommend devices with a larger supply tank.

For clear water fun

**Tested separation stations:
Retrofitting is mandatory – no grandfathering**



ST 5-7.2 floor-standing



Cleaning work in equestrian sports, animal breeding, stables but also in trade and industry only with consistent compliance with DIN EN 1717 with protection against recontamination through free outlet as is the case in our separation stations..



ST 5-4.3



ST 5-7.2

For more information, scan the QR code or enter the item number in the dehoust.com

Drinking water separation station

Safety separation station – ST-AQF 570/SV 5-40



Safety separation station with integrated pressure boosting system

The ST-AQF 570 safety separation station consists of a storage tank with a drinking water connection in accordance with DIN EN 1717, a mechanical float valve for regulating the drinking water replenishment and a submersible pump with integrated pressure switch for supplying the withdrawal points.

Technical data STAQF 570/SV 540

Art. no. 812903	ST-AQF 570/SV 5-40
Flow rate Q_{max}	5.5 m ³ /h
Conveying height H_{max}	48 m
Useful volume tank	495 liters
Dimensions (HxWxD)	1,430 x 720 x 720 mm
Weight	32 kg
Supply voltage	230 V / 50 Hz



Cat 5 Break tanks according EN 1717 with replenishment and overflow AB EN 13077



Our wide range of plastic storage tanks (PE-DF and AQF) is the basis for individual break tanks from 570 litres up to 4000 litres.

More details see rainwater storage at page 18



DehoustCONNECT – Drinking water separation station

Safety separation station with double pump system

DehoustCONNECT safety separation station to protect drinking water against process water of hazard class 5 in accordance with DIN EN 1717, consisting of double pump system with intelligent DehoustCONNECT control system as well as a touch screen and large AQF storage tank.

- ▶ DehoustCONNECT control for regulating and monitoring the system functions
- ▶ Large volume receiver tank type AQF
- ▶ Drinking water feeding in accordance with DIN EN 1717 type AB to protect drinking water against process water of hazard class 5
- ▶ Drinking water feeding type AB via KTW W270 approved solenoid valve with automatic closing should there be a malfunction (power failure)
- ▶ Powerful pressure boosting system with pressure sensor and adjustable switching points
- ▶ Cover for double pump unit
- ▶ Membrane expansion tank 8 liters
- ▶ Water detector for moisture monitoring in the technical room
- ▶ Web-enabled CONNECT control for remote inquiry and operation via smartphone, tablet or PC
- ▶ Stagnation protection of the drinking water line (optional auto-drain function available to prevent stagnation in the tank)
- ▶ The feed tanks can be selected as needed



Technical data DehoustCONNECT safety separation stations

	6-40 STS	8-40 STS	8-50 STS	14-40 STS
Article no.	814404	814405	814406	814409
max. flow rate pump (m³/h)	3.3	4.8	4.8	7.2
max. flow rate double pump (m³/h)	6	9	9	14
max. flow volume pump (m)	48	42	58	47
Useful volume tank (l)	500			
Dimensions: HxWxD (mm)	1,870x730x1,800			
Weight kg	95	93	100	100

Greywater recycling

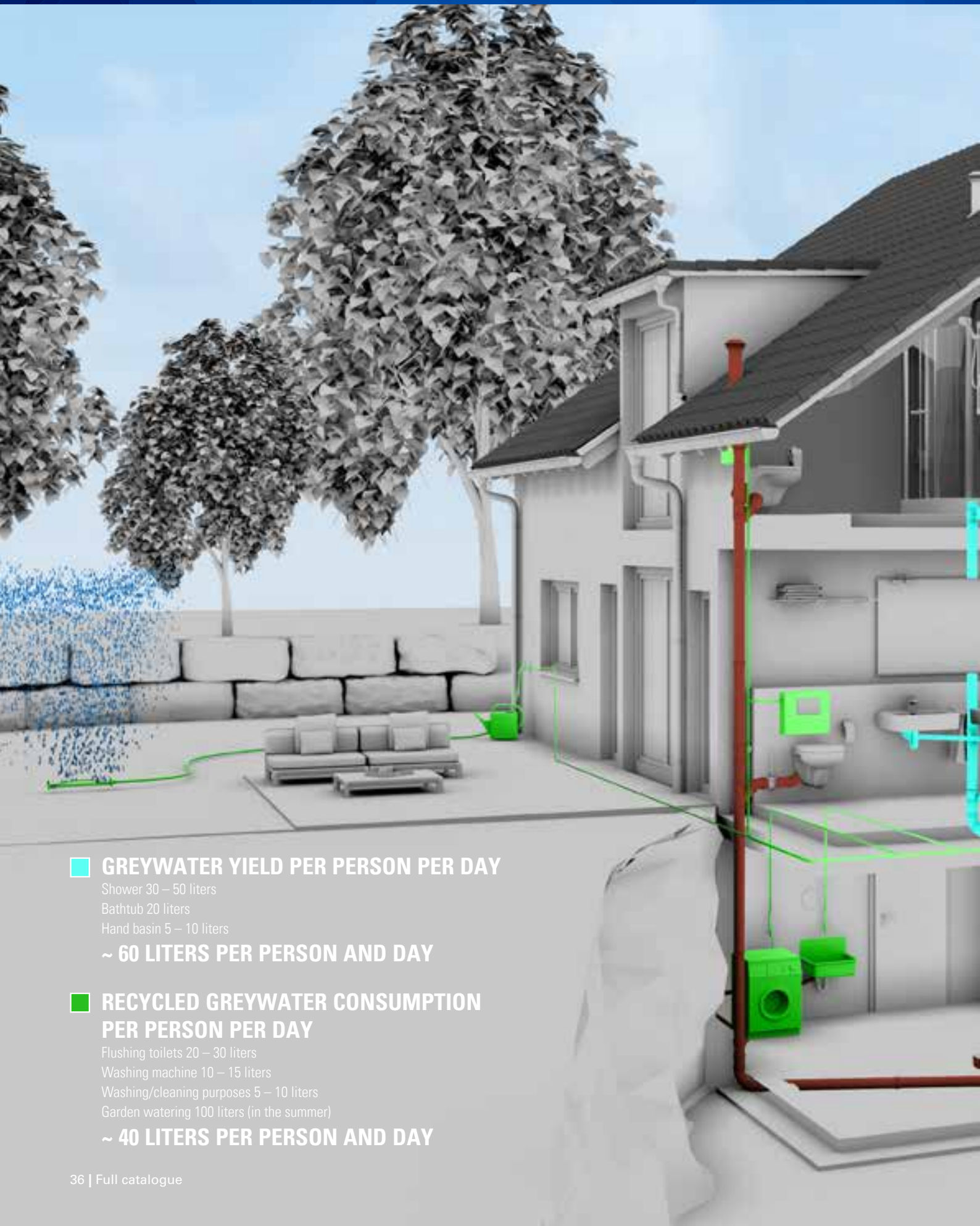

■ GREYwater YIELD PER PERSON PER DAY

Shower 30 – 50 liters

Bathtub 20 liters

Hand basin 5 – 10 liters

~ 60 LITERS PER PERSON AND DAY

■ RECYCLED GREYwater CONSUMPTION PER PERSON PER DAY

Flushing toilets 20 – 30 liters

Washing machine 10 – 15 liters

Washing/cleaning purposes 5 – 10 liters

Garden watering 100 liters (in the summer)

~ 40 LITERS PER PERSON AND DAY

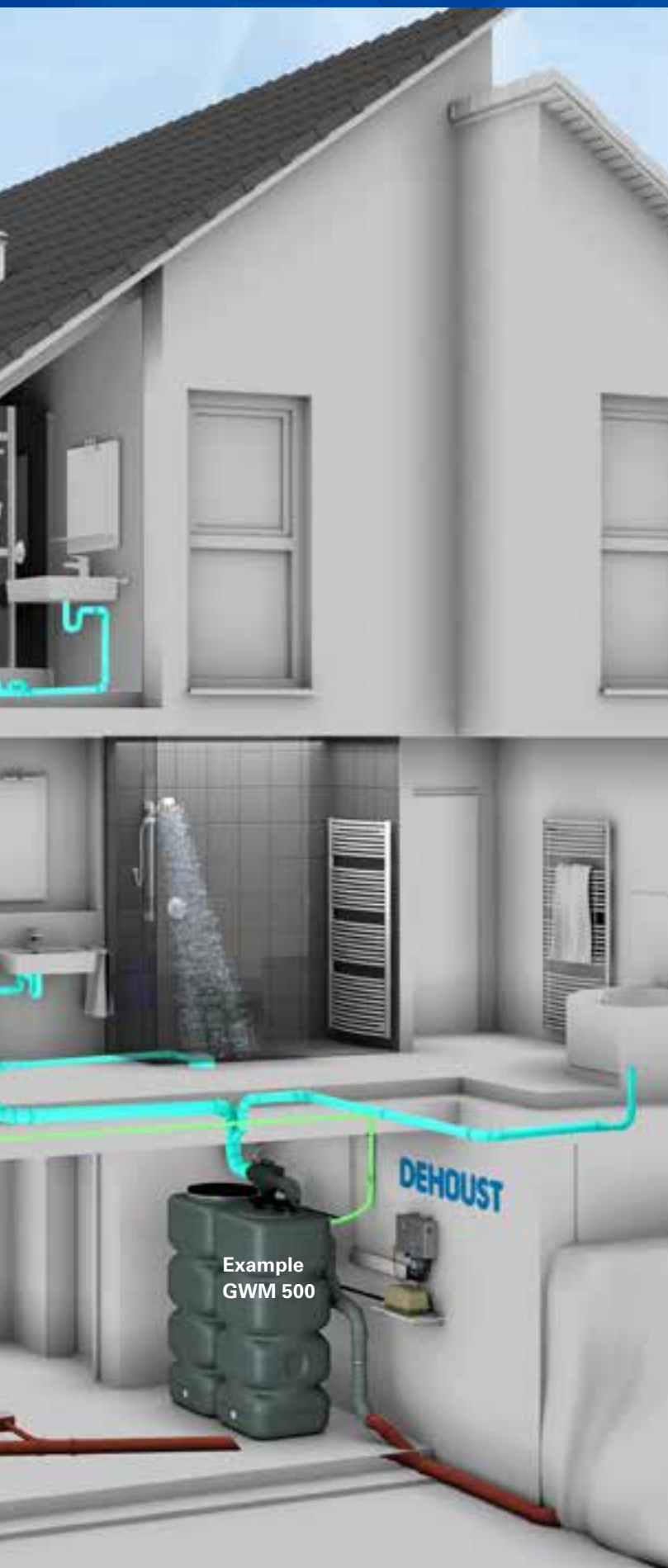

Example
GWM 500

USING GREYwater TO CONSERVE DRINKING WATER AND SAVE MONEY

Germans consume an average of around 120 liters of precious drinking water every day. Most of this is used for personal hygiene.

This so-called “greywater”, which can account for around 50% of all domestic wastewater, then flows into the sewage system unused. Especially given that climate change and its consequences in the form of heat waves and droughts are becoming ever more visible, this is an enormous waste of our most precious resource!

With a greywater system you are not only doing something beneficial for the environment, you are also doing something beneficial for your own wallet. When it is collected and treated for things like flushing toilets, for washing machines or for watering the garden, drinking water consumption can be significantly reduced – as can the cost of both drinking water and sewage fee.

DEHOUST offers the right system technology for your needs – from the low cost model to the high-tech system – highly efficient, with high operational reliability and minimal maintenance costs. Our plants purify greywater in an environmentally-friendly manner, but also ensure the water supply for your household in the event of a greywater shortage. This can also be done digitally, if desired: With DehoustCONNECT, you or the fitter can easily control the system using the Internet or an app.

This brochure outlines the most important advantages of greywater utilization and presents our system models in a wide range of sizes, for single-family homes as well as residential complexes, hotels or fitness studios, for example.

Your advantages

- ▶ Save water by using it twice
- ▶ Short payback periods
- ▶ Excellent storage stability of the process water
- ▶ Versatile control system
- ▶ Can be combined with rainwater harvesting

Benefit from DEHOUST's experience.

We would be happy to help you!



Greywater Fact Check



What is greywater?

“Greywater” is fecal-free, low-polluted water that is produced, for example, after showering or washing hands. The water quality of the treated greywater conforms with the European standard EN 16941-2 as well as other common standards such as the British Standard 8525-1 and the European standard for bathing water 2006/7 / EC.

How does greywater recycling work?

The treatment of the slightly polluted water is carried out in a purely mechanical-biological way. The most modern and safest wastewater treatment technology currently available is used: biomembrane technology (BMT). Once the water has been treated, it is available again as absolutely clear, odorless and, most importantly, germ-free process water.



What can greywater be used for?

You can use the treated greywater wherever drinking water quality is not absolutely necessary! This includes, for example, flushing toilets, watering gardens or cleaning work.

How much money can you save with a greywater system per year?

The reduction in both drinking water costs and wastewater charges means that the investment pays for itself very quickly.

Who can benefit from such a system?

The systems can be used flexibly and, thanks to their modular construction, can be designed for any requirement – from single-family homes to systems for large properties!

We would be happy to support architects and building owners during their planning phases.

What are the constructional requirements?

The greywater sources are connected to a separate wastewater line. The consumers, for example toilets or garden, are supplied by a service water pipe.

Are there subsidies available?

YES! A significant number of municipalities offer subsidies for the purchase of a greywater system. Please get in touch with your local authorities for more details.

Building Certifications also known as “Green Building”

There are various certification systems available around the world. Greywater recycling and as well as rainwater harvesting is an elementary part for every certification provider.

If you have any questions regarding building certifications, contact the respective certification bodies for your country.



**NEED MORE
INFORMATION?
WANT TO SEE MORE?**

[View the video here](#)

Treatment steps and main components

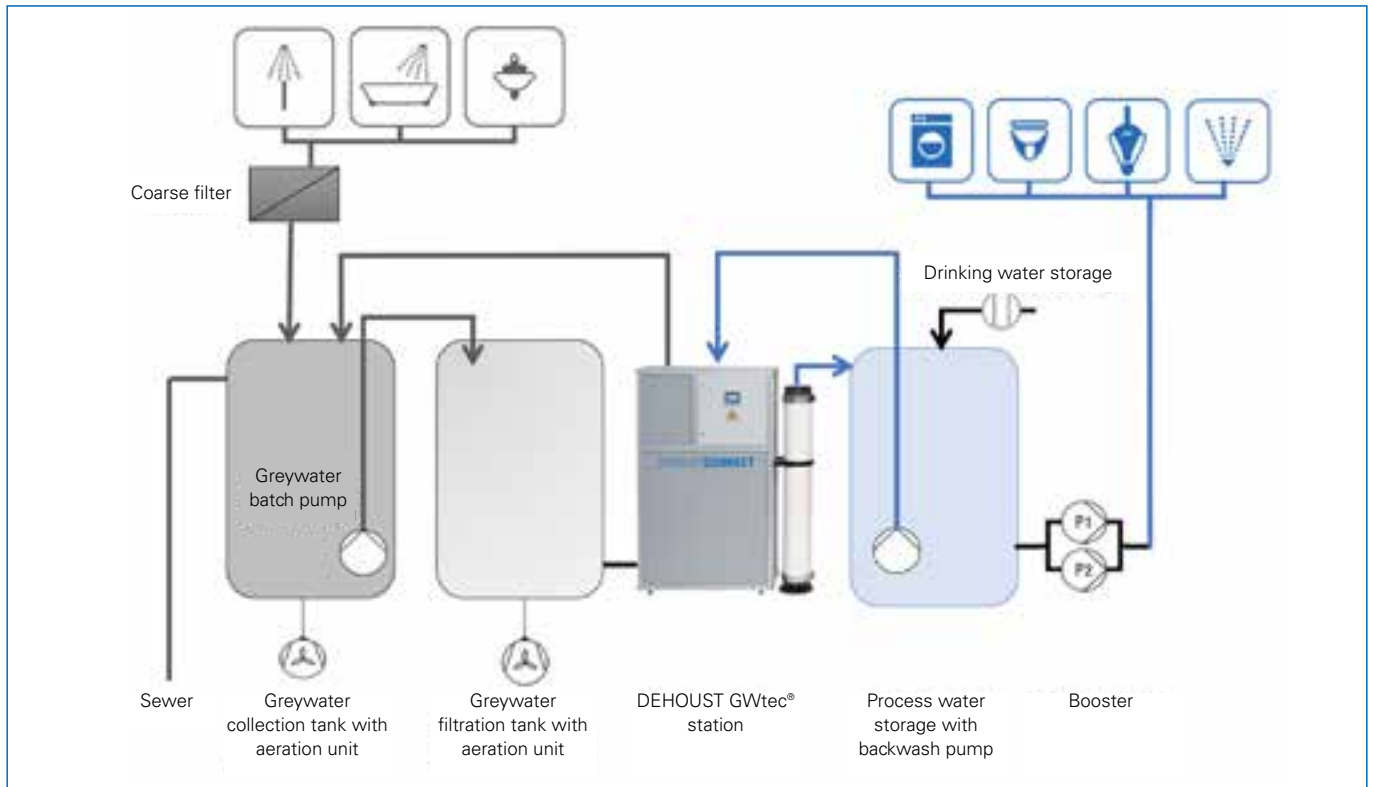

In a multi-stage treatment process, the collected greywater is initially subjected to biological treatment and then the remaining dirt particles are removed using DEHOUST GWtec® membrane filtration.

Rough filtration

Greywater collected separately is first freed from its undissolved water contaminants including hair and textile lint.

Aerobic biological purification

All organic contaminants, like shower gel and soap, are biologically degraded by special wastewater bacteria in the aerated greywater tank.

Sedimentation

Aeration in the filtration tank is controlled to settle particles and suspended solids prior to ultrafiltration.

Ultrafiltration

The DEHOUST GWtec® membrane filter begins to gently filter the pre-treated greywater. Ultrafiltration is followed by a short flushing of the membrane filter with process water. The control system manages all processes fully automatically

and regulates the cleaning process depending on the level of greywater contamination for the best possible results.

Storing process water

Due to its extremely low nutrient content (biological purification) and the hardly detectable residual biomass (ultrafiltration), the treated greywater can be stored for extended periods and reused without concerns.

Drinking water storage

If no treated service water is available in the storage tank, the integrated drinking water storage (EN 1717) secures the water supply.

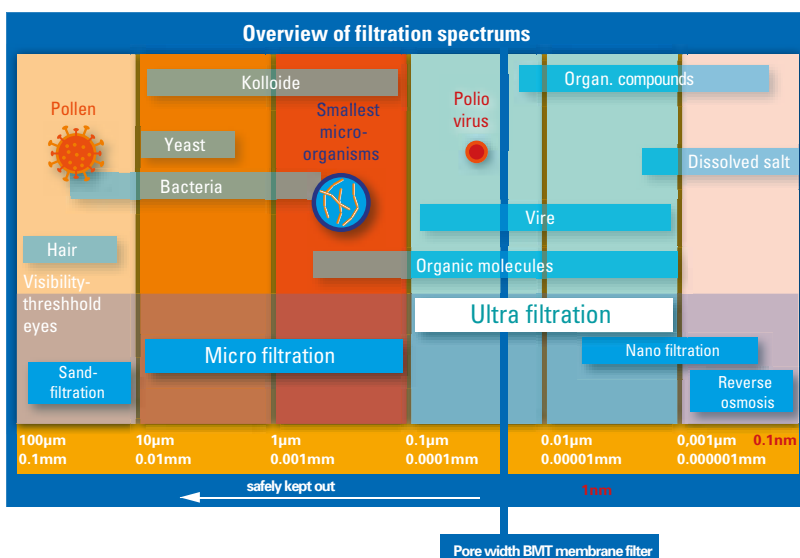

For Single-Family Homes

GREYWATER RECYCLING FOR SINGLE-FAMILY HOMES

The average family uses about 65% of its drinking water for showering, bathing and washing hands. Rather than letting this water disappear unused in the sewage system, use the water a second time for flushing your toilets, washing laundry, domestic cleaning and watering your garden with a greywater system from Dehoust. Save money and, above all, drinking water!

With the GWR 300 we offer a simple greywater recycling system for private users, preferably for garden irrigation with a daily output of up to 300 liters, depending on the quality and the time of occurrence of the greywater.

The GWM 500 is a fully automatic system with integrated drinking water feeding according to DIN EN 1717 and a powerful submersible pressure pump. The control system is designed for the integration of a rainwater cistern with feeder pump.

All plants with submerged membrane filters and biological pre-treatment for hygienically perfect process water.
More information at dehoust.com (enter article number in search)



	GWR 300	GWM 500
Residents	2-4	2-6
Submerged membrane filter with aeration	yes	yes
Output volume	up to 300 l/d	500 l/d
Puffer volume greywater	200 l	200 l
BW storage	600 l	600 l
Pressure increase	optional	Submerged pressure pump including
Drinking water feed	optional	including
Control	no	yes
Rainwater integration	no	possible
Articles	813221	813330



For medium to larger residential projects

BMT TECHNOLOGY WITH SUBMERGED ULTRAFILTRATION FOR GREYWATER SYSTEMS UP TO 3,000 LITERS PER DAY WITH THE GWM WATER MANAGER

Would you like it to be a little bit larger? Particularly when it comes to larger properties, greywater utilization offers substantial potential for savings – both in terms of operating costs and drinking water consumption. Save year after year with Dehoust greywater utilization and increase the attractiveness of your property with green building technology.

We support you with a solid, fully automatic greywater treatment system for in-house installation, equipped with a coarse filter, a large-volume greywater storage tank, a compact BMT unit, a service water storage tank with integrated drinking water separation station, a control unit and a suitable pressure boosting system.

Proven treatment technology since 2009



GWM 1150



GWM 3000

Key topics at a glance:

- ▶ modular concept of the BMT membrane filter tank
- ▶ all plant components are transportable by door and by hand
- ▶ environmentally-friendly biomechanical treatment process
- ▶ no chemicals
- ▶ fully automatic control unit for regulation and monitoring of all operating processes
- ▶ volt-free alarm output for building management system
- ▶ compatible with rainwater harvesting systems
- ▶ proven and safe treatment technology in currently more than 200 Dehoust greywater systems



The GWM control unit also manages the supply of rainwater from the cistern with the feeder pump (article no. 812966)

Greywater recycling system	Residents	Treatment output	Greywater storage volume	Process water storage volume	Article
GWM 950*	20 – 30	950 Liter / day	500 liters	500 liters	813345
GWM 1150	30 – 40	1,150 Liter / day	600 liters	600 liters	813355
GWM 2000	40 – 60	2,000 Liter / day	1.800 liters	1.700 liters	813388
GWM 3000	60 – 80	3,000 Liter / day	2.500 liters	2.700 liters	813398

* Type suitable for technology rooms with low room heights > 2,000 mm; all other types require room heights > 2,200 mm

For residential complexes, sports centers, hotels, etc.

GREYWATER SYSTEMS UP TO 20,000 LITERS PER DAY WITH DEHOUST GWtec® CONNECT

With our generously-dimensioned greywater systems, starting at a consumption of 3,000 liters per day, for hotels, for example, your operating and maintenance costs can be substantially reduced – while the level of water quality remains high at the same time. The plant can be variably adapted to the existing space conditions.



LATEST GENERATION in the area of greywater recycling



Greywater system DEHOUST GWtec® 140

Key topics at a glance:

- ▶ environmentally-friendly treatment procedure without chemicals
- ▶ energy-efficient technology
- ▶ dry-mounted hollow fiber membrane filters for fast and easy maintenance
- ▶ dynamic control of treatment performance thanks to SmartFiltrationControl
- ▶ control system with high-resolution 4" touchscreen display
- ▶ integrated web interface provides real-time access to all plant processes via smartphone, tablet and PC
- ▶ compatible with rainwater harvesting systems

Standard equipment:

DEHOUST GWtec® ControlUnit, DEHOUST GWtec® membrane filter, filtrate pump, level transmitter, flow meter, switching valves, greywater filtration tank and aeration unit

DEHOUST Grey Water recycling system	*Residents	**Treatment output m ³ /day	Weight kg	Article
DEHOUST GWtec® 140 W	up to 100	3 – 5	130	813371
DEHOUST GWtec® 240 W	200	10	190	813372
DEHOUST GWtec® 340 W	300	15	260	813373
DEHOUST GWtec® 440 W	400	20	330	813374

* determined with operating water consumption 50 liters/resident and day (e.g. for flushing toilets, cleaning,...).

** net treatment capacity including membrane filter backwash; treatment capacity dependent on operating settings and greywater contamination.

DEHOUST GWtec® Membrane Technology

DehoustCONNECT for more safety and comfort: Let the system work and manage it exactly the way you want. DehoustCONNECT connection is simple and considers the highest security standards for the home LAN network. The web interface establishes an outgoing VPN connection via TCP port 1194 to the DehoustCONNECT server. This port must be enabled in the firewall for an outgoing TCP connection by the operator.

All of the data communication is safeguarded against unauthorized access and only runs on the company's own DehoustCONNECT server.

The DehoustCONNECT control unit's integrated web interface provides a wide range of remote operation options:

- ▶ reviewing and modification of operating parameters to optimize performance
- ▶ live monitoring of operating processes and data
- ▶ error analysis and correction via remote access
- ▶ sending alarm and status messages via e-mail
- ▶ automatic software updates

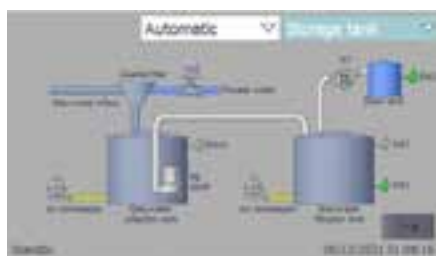
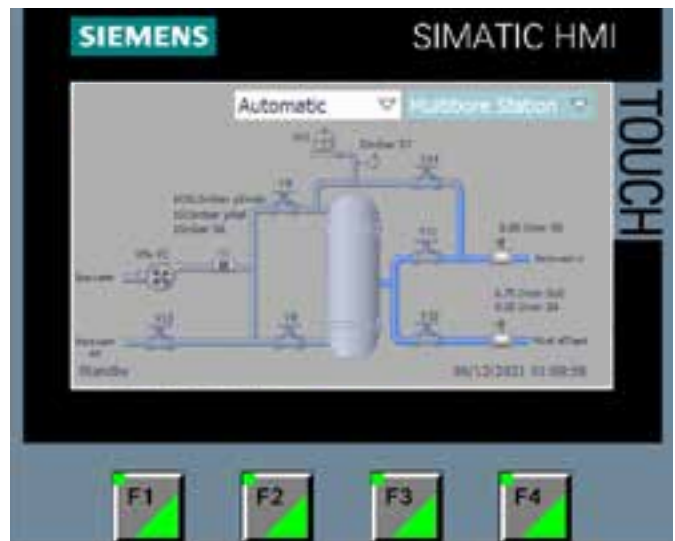

Date	Pressure	Flow rate	Power rate
2012-01-01 10:00	1.00 bar	1.00 m³/h	1.00 kW
2012-01-01 11:00	1.05 bar	1.05 m³/h	1.05 kW
2012-01-01 12:00	1.10 bar	1.10 m³/h	1.10 kW
2012-01-01 13:00	1.15 bar	1.15 m³/h	1.15 kW
2012-01-01 14:00	1.20 bar	1.20 m³/h	1.20 kW
2012-01-01 15:00	1.25 bar	1.25 m³/h	1.25 kW
2012-01-01 16:00	1.30 bar	1.30 m³/h	1.30 kW
2012-01-01 17:00	1.35 bar	1.35 m³/h	1.35 kW
2012-01-01 18:00	1.40 bar	1.40 m³/h	1.40 kW

Supplementary components ...

Coarse filter DEHOUST MAX I

with DN 100 ports including backwashing

control via DEHOUST GWtec® unit

Article 812651

Coarse filter DEHOUST MAX II

with DN 150 ports including backwashing

control via DEHOUST GWtec® unit

Article 812657



Greywater collection tank 1,500 – 4,000 liters

with inlet DN 100/500 and overflow nozzle DN 100/150

control via DEHOUST GWtec® unit

Article 962051 – 1,500/1,350 liter volume

Article 962053 – 2,000/1,800 liter volume

Article 962055 – 2,500/2,300 liter volume

Article 962057 – 3,000/2,800 liter volume

Article 962059 – 4,000/3,750 liter volume



You will find expansion tanks here <https://www.dehoust.com/5243>



Process water storage including drinking water storage

In accordance with DIN EN 1717 with overflow nozzle DN 100/150

control via DEHOUST GWtec® unit

Article 962050 – 1,500/1,350 liter volume

Article 962052 – 2,000/1,800 liter volume

Article 962054 – 2,500/2,300 liter volume

Article 962056 – 3,000/2,800 liter volume

Article 962058 – 4,000/3,750 liter volume



You will find expansion tanks here <https://www.dehoust.com/5243>



... for DEHOUST GWtec® technology

Aeration unit

- ▶ Aeration unit for greywater collection tank
- ▶ Article 813440

- ▶ Extension package aeration unit for greywater collection tank
- ▶ Article 813442



Greywater batch pump

- ▶ Greywater batch pump DOC 3
- ▶ Volume rate: max. 8.7 m³ / h
- ▶ Delivery height: max. 7 m
- ▶ Article 813443

- ▶ Greywater batch pump DOC 7
- ▶ Volume rate: max. 13.8 m³ / h
- ▶ Delivery height: max. 11 m
- ▶ Article 813444



Automatic drainage system for process water storage

- ▶ Automatic drainage system for process water storage
- ▶ Article 813456



Rainwater harvesting package

- ▶ DEHOUST GWtec® rainwater feeder pump for automatic replenishment of rainwater to the process water storage tank including fill level indicator rainwater cistern
- ▶ Article 813475



All supplementary components are supplied and controlled through the DEHOUST GWtec® Station

Rainwater harvesting



Rain Manager highlights

- ▶ Rain Manager from Dehoust has enough pressure for sprinklers and drip irrigation
- ▶ ensure the supply of water to toilets even in the event of rainwater shortage by replenishing water as needed
- ▶ system is mounted on the wall in the technical room to save space
- ▶ protects the drinking water supply from recontamination
- ▶ can be combined with all cisterns



Yield of rainwater per year for a single building

- ▶ Average roof size: 100 m²
- ▶ Average rainfall yield: 805 liters per m²
- ▶ Runoff coefficient sloped roof: 0.8
- ▶ Filter coefficient: 0.95
- ▶ ~ Annual yield: 61,180 liters

Process water consumption

- ▶ Per person per day: approx. 40-50 liters
- ▶ Toilet flushing: 20-30 liters
- ▶ Cleaning: 5-10 liters
- ▶ Washing machine: 10-15 liters
- ▶ Total for 4 people: approx. 50,000 liters
- ▶ plus garden watering: 100 l/m²
- ▶ Total per year: up to 70,000 liters

Pressure boosting with automatic control is an indispensable component of a fully-functional rainwater system. Our Rain Manager combines the powerful pump, a flow monitor optimized for rainwater harvesting and a control system for fully automatic operation. When the rainwater cistern is empty, Rain Manager supplies only as much drinking water as is currently needed. The drinking water feeding is carried out in the free outlet in accordance with DIN EN 1717, thus ensuring compliance with the strict requirements of the drinking water ordinance.

RM3

New: Flow switch with larger membrane. Larger potable water tank for more feed volume.



Outstanding technology for the smallest of spaces

The Rain Manager RM3 is a compact device that is ideal for small technical rooms. The fully-equipped unit includes the pump for safe supply to users, the control technology for drinking water feed-in depending on demand as well as the required system separation in accordance with DIN EN 1717.

Areas of application:

One and two-family houses with medium-sized gardens for irrigation with lawn sprinklers

Technical data Rain Manager RM3

Art. no. 812240

el. Output	Flow rate		Mains-voltage	Connections			Emergency-overflow	Dimensions H x W x D mm	Weight
	Qmax	Hmax		Drinking water	Suction-side	Pressure side			
805 W	3.2 m ³ /h	44 m	230 V / 50 Hz	3/4"	1"	1"	DN 50	580 x 380 x 295	18 kg

Installation

The Dehoust Rain Manager is characterized by ease of installation. Simple wall mounting and sensible connection to the existing piping systems guarantee efficient installation.

RM5

With new domestic waterworks – even more powerful and quieter.



Performance in all areas

The fully automatic Rain Manager RM5 is the solution when high performance is required, such as in the garden. In addition to the security of supply, this Rain Manager also offers a high level of convenience and, with the DVGW certificate, a verifiably assured system separation.

Areas of application:

One and two-family houses with large gardens for pop-up lawn sprinklers

Technical data Rain Manager RM5

Art. no. 815092

el. Output	Flow rate		Mains-voltage	Connections			Emergency-overflow	Dimensions H x W x D mm	Weight
	Qmax	Hmax		Drinking water	Suction-side	Pressure side			
1,200 W	4.8 m ³ /h	52 m	230 V / 50 Hz	3/4"	1"	1"	DN 70	700 x 595 x 305	20 kg

C-Class CONNECT – Rain Manager

Rainwater harvesting

DehoustCONNECT makes the proven C-Class even safer and more user-friendly.

With an extension vessel, the switching frequency of the pump can be reduced and the service life extended. Information on design can be found in our data sheets.



Article no.	Description	Flow rate Q_{max}	Flow volume H_{max}
814354	CONNECT 6-40 C-Class	6 m ³ /h	46 m
814355	CONNECT 8-40 C-Class	9 m ³ /h	42 m
814356	CONNECT 8-50 C-Class	9 m ³ /h	58 m

Rain Manager accessories C-Class CONNECT

Article no.	Description
812448	Rainwater tank level indicator
812483	Rainwater stop 1 1/4"



Industry 4.0

Equipment and advantages C-Class

- ▶ DehoustCONNECT control for regulating and monitoring the system functions
- ▶ Drinking water feeding type AA via KTW W270 approved solenoid valve with automatic closing should there be a malfunction (power failure)
- ▶ Powerful double pump system with pressure sensor and adjustable switching points
- ▶ **Extension vessel 8 litres**
- ▶ Moisture detector for installation room
- ▶ Web-enabled CONNECT control for remote inquiry and operation via smartphone, tablet or PC



C Class



Hybrid system

CONNECT hybrid system including feeder pump

The hybrid system, consisting of double pump system CONNECT with storage tank AQF, is intended for use in large-scale rainwater systems. It switches the submersible pump included with the system (with float switch and additional dry-running protection) in the cistern and, if required, automatically controls the switchover to drinking water operation in accordance with EN 1717.

The electrically-controlled and monitored magnet valve avoids pressure surges in the network and closes automatically in the event of a power failure. DehoustCONNECT prevents stagnation in the supply line in line with the relevant standards.



Article no.	Description	Flow rate Q_{max}	Conveying height H_{max}
814324	CONNECT 6-40 Hybrid	6 m ³ /h	46 m
814325	CONNECT 8-40 Hybrid	9 m ³ /h	42 m
814326	CONNECT 8-50 Hybrid	9 m ³ /h	58 m
814329	CONNECT 14-40 Hybrid	14 m ³ /h	47 m
Accessories			
812448	Rainwater tank level indicator in the CONNECT control unit		
812483	Rainwater stop 1 1/4"		
814335	Additional feed-in unit 1" with receiver tank		

The feeder pump is designed for a max. conveying height of 5 m and pressure line of 25 m.

Plastic rainwater tanks – in door



Basis tank 2,000 liters



- ▶ Protection against algae formation due to lightproof black polyethylene
- ▶ integrated calmed inlet DN 100 and overflow siphon DN 100
- ▶ modular system, expandable as desired
- ▶ large opening for tank cleaning or installation of a submersible pump

Our above-ground PE cellar tanks are quality-assured by the RAL quality seal "Rainwater systems PE storage tanks" and comply with the KTW recommendation.

Article no.	Description	Length mm	Width mm	Height mm	Height approx. mm	Height over-flow mm	Weight kg
962003	Basic tank RWN-O 1100 B	1,400	820	1,400	1,470	1,130	55
971301	Extension tank 1100 DF	1,400	720	1,400	–	–	53
962005	Basic tank RWN-O 1500 B	1,560	820	1,640	1,710	1,390	73
971303	Extension tank 1500 DF	1,560	720	1,640	–	–	71
962007	Basic tank RWN-O 2000 B	2,070	820	1,690	1,760	1,375	113
971305	Extension tank 2000 DF	2,070	720	1,690	–	–	111
962012	Basic tank RWN-O 2500 B	1,870	1,095	1,650	1,720	1,330	118
971306	Extension tank 2500 DF	1,870	995	1,650	–	–	116
962061	Basic tank RWN-O 3000 B	2,230	1,095	1,650	1,720	1,330	169
971307	Extension tank 3000 DF	2,230	995	1,650	–	–	166
962063	Basic tank RWN-O 4000 B	2,430	1,095	1,950	2,020	1,500	239
971309	Extension tank 4000 DF	2,430	995	1,950	–	–	236



Types 1100 and 1500 with a upper connection 2", 2500 to 4000 with 3 connections 2"

Basement tank with calmed inlet and overflow sip

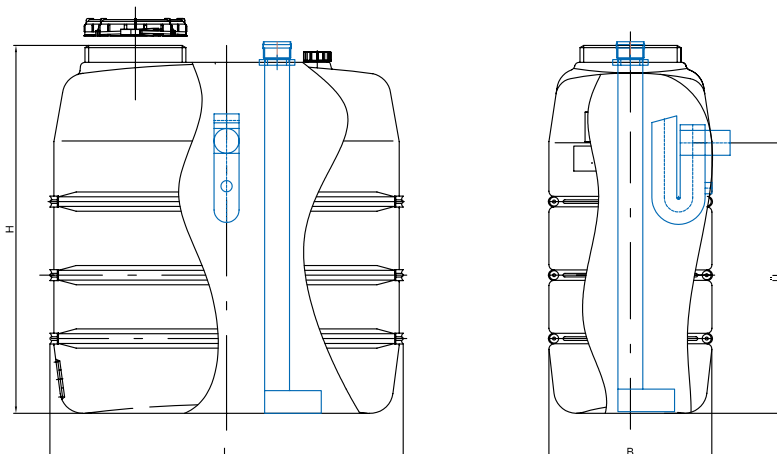



Article no.	Description
Inline filter for underground installation and in house installation for up to 450 m² roof area	
810745	Inline filter 450 for underground installation
811184	Inline filters for in-house installation
Accessories	
810746	Revision pipe 0.75 m



Article no.	Description
Drinking water feeding for PE storage tanks	
810400	Magnet valve 1/2" with float switch 230 V and 10 m cable
810397	Magnet valve 1" with float switch 230 V and 10 m cable
810398	Magnet valve 1 1/2" with float switch 230 V and 10 m cable
810399	Magnet valve 2" with float switch 230 V and 10 m cable

Servo-controlled magnet valves for drinking water feeding with direct connection to PE storage tanks, AQF tanks or rainwater storage tanks. The lateral rectangular emergency overflow required for compliance with DIN EN 1717 can be attached to the tank at the factory upon request.

Accessories lower circulation line for unlimited storage volume



Article no.	Description
Accessories Battery installation with individual shut-off for storage tank PE-DF	
971565	Basic package DF connecting pipe DN 50 for 2 PE Dom tanks with two 1 1/2" taps
971570	Extension DF for connecting further PE Dom tanks with a 1 1/2" tap

Lower connection line with connection flange and stopcock 1 1/2" for PE storage tanks for on-site connection plastic pipe DN 50 (outer diameter 63 mm).



Article no.	Description
Accessories Battery installation with individual shut-off for storage tank PE-DF	
971555	Basic package DF connecting pipe DN 50 for 2 PE-Dom tanks
971560	Extension DF for connecting additional PE-Dom tanks
71645	Stopcock 2" for shutting off the connecting line DN 50
62276	Venting hood 2"

71645 Stopcock with 2" IT for shutting off the connecting line.

Rainwater harvesting

Domestic waterworks Aspri 15 4 GG with Kit 02



The Aspri cast iron domestic waterworks is a high quality, specially designed for rainwater harvesting, self-priming, multi-stage, horizontal centrifugal pump. It is highly efficient and is suitable for continuous operation. The domestic waterworks is equipped with a flow monitor Kit 02 for automatic operation of the pump. The pressure gauge that is included shows important information about the current pressure.

Domestic waterworks Aspri with Kit 02

Article no.	Description	kW	Flow rate Q_{max}	Conveying height H_{max}	Connection voltage
810875	Aspri 15-4 GG	0.80	3.5 m ³ /h	44 m	230 V /50 Hz



Drinking water feed into the cistern

Article no.	Description
	Electric TWNSP consisting of solenoid valve ½" 230 V, hopper DN 50 for free outlet, intermediate plug and float switch
810393	TWNSP with 10 m cable
810394	TWNSP with 20 m cable

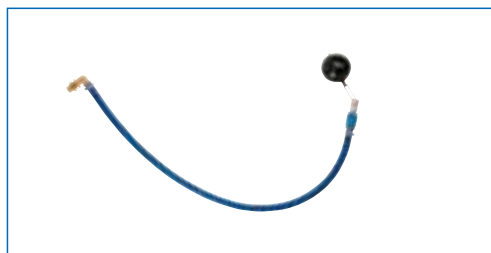

Floating extraction

Article no.	Description
810541	Floating extraction TWIST 2 m
810542	Floating extraction TWIST 3 m



Tank accessories

Article no.	Description
810442	Calmed inlet DN 100
810439	Overflow siphon DN 100

You will find a wide range of accessories at www.dehoust.com under Products/Accessories in the Process Water section.

Safe supply for home and garden



Submersible pumps – bringing the pressure you need

Irrigation of large gardens places high demands on the pressure boosting system. Sprinkler systems require appropriate pre-pressure for pop-up sprinklers to extend.

Submersible pump SubDive 900

With integrated automatic switch and floating extraction. With dry-running protection and electronically controlled automatic reset.

Ideal for use without a make-up device and for garden irrigation in small and medium-sized systems.

If replenishment is required, it is possible to combine it with an electric drinking water replenishment (Art. No. 810393 or 810394), which fills the cistern with drinking water.

	SubDive 900
Article number:	810043
Electrical power	900 W
Flow rate Q_{max}	6 m ³ /h
Conveying height H_{max}	45.8 m

Domestic waterworks FU 5



The FU 5 is an automatic pressure boosting system with frequency converter that consists of:

- ▶ a highly efficient self-priming pump
- ▶ an expansion tank
- ▶ a pressure and flow sensor
- ▶ a check valve

A very compact, quiet, autonomous and powerful system.

A sophisticated electronic frequency converter at the heart of the unit intuitively controls the entire:

- ▶ Keeps the pressure of the system constant by regulating the speed of the pump in coordination with the water required.

Article no.	Description	
814286	max. flow rate in m ³ /h	7.2
	max. conveying height in m	55
	Supply voltage	230 V / 50 Hz / 16 A
	Rated current in A	10
	Connected load in W	1,500

Can also be combined to form a double pump!



Tanks and storage containers made of polyethylene

From 570 to 4,000 liters, plastic storage containers deliver the ideal solution for almost any application.

Process water, surge water in swimming pool construction, industrial wastewater, fire water, cooling water, rainwater and greywater.

The HD-PE used is physiologically safe and meets the requirements of the German Federal Institute for Risk Assessment (BfR). HD-PE is food safe and chemical resistant.

PE storage tanks are also suitable and approved for water-polluting liquids. More on page 64 and the certificates for the individual products at www.dehoust.com.



Our products:

- ▶ **Plastic storage tanks DF**
- ▶ **Plastic storage tanks AQF**
- ▶ **Collecting trays, round tanks and rectangular tanks**



Heat.
Energy. Water.

STORAGE & UTILIZATION

3

Plastic storage tanks



PE 2000DF with Basic package 971565

HD-PE is physiologically harmless and complies with BfR Recommendation III Polyethylene as well as the KTW Guideline for domestic installations and the KSW Recommendation for drinking water installations.



Flange with stopcock

Wide range of applications

The versatile plastic storage tank type PE-DF made of high-quality polyethylene (HD-PE) is resistant to numerous media and suitable up to a density of 1.15 g/cm³.

The PE storage container is optimally designed for indoor storage. The slight transparency of the natural-colored tanks allows visual level control at all times.

The lower flange can be drilled to connect a valve or to join the tanks. (see installation manual).

The tanks are also available in black polyethylene for an extended range of use and increased UV resistance.

HD-PE is chemical resistant, physiologically harmless and food safe. The tanks meet the requirements of the KTW assessment basis, appendix A (as of 2021-03) in drinking water domestic installations and swimming pool construction in the cold and hot water sector.

PE storage tank with galvanized steel banding, dome DN 400 and bottom connection flange

Article no.	Description	Dimensions mm (L x W x H)	Weight
971294	PE 1100 DF natural	1,400 x 720 x 1,400	55 kg
971301	PE 1100 DF black		
971295	PE 1500 DF natural	1,560 x 720 x 1,640	70 kg
971303	PE 1500 DF black		
971253	PE 2000 DF natural	2,070 x 720 x 1,690	110 kg
971305	PE 2000 DF black		
971605	PE 2500 DF natural	1,870 x 995 x 1,650	115 kg
971306	PE 2500 DF black		
971593	PE 3000 DF natural	2,230 x 995 x 1,650	165 kg
971307	PE 3000 DF black		
971589	PE 4000 DF natural	2,430 x 995 x 1,950	235 kg
971309	PE 4000 DF black		

Article no.	Description
Stopcock for single tank	
971641	Stopcock 1 ½" with PP flange 1 ½" for single tank
971642	Stopcock 2" with PP flange 2" for single tank

PE storage tank – type DF

Accessories lower circulation line for unlimited storage volume



Accessories 1x base, 3x extension



Article no.	Description
Accessories Battery installation with individual shut-off for storage tank PE-DF	
971565	Basic package DF connecting pipe DN 50 for 2 PE Dom tanks with two 1 ½" taps
971570	Extension DF for connecting further PE Dom tanks with a 1 ½" tap

Lower connection line with connection flange and stopcock 1 ½" for PE storage tanks for on-site connection plastic pipe DN 50 (outer diameter 63 mm).



Article no.	Description
Accessories Battery installation with individual shut-off for storage tank PE-DF	
971555	Basic package DF connecting pipe DN 50 for 2 PE-Dom tanks
971560	Extension DF for connecting additional PE-Dom tanks
71645	Stopcock 2" for shutting off the connecting line DN 50
62276	Venting hood 2"

71645 Stopcock with 2" IT for shutting off the connecting line.



Lower connection line 2" without individual shut-off of the tanks.



Round tanks and rectangular tanks



Double plastic flange made of PE with GRP loose flange

Individual solutions from serial production

Storage tanks from Dehoust are very often the inexpensive solution for the storage of liquids thanks to series production on state-of-the-art blow molding lines.

Because the company has its own plastics workshop, further application possibilities and advantages are opened up for the customer: the welding in of additional nozzles and additional dome DN 600, the fitting of flanges and distribution pipes are carried out by Dehoust's internal specialists.



Connection pipe with 2" female thread

The right solution for whatever you need

Specially adapted accessories make the use of PE tanks even easier.

A broad range of applications in process technology, swimming pool construction and fire-fighting water technology require large quantities of water in a short time. Appropriately dimensioned flange connections ensure the right volume flows and the balancing of the tank performance. The additional piping is laid without tension.



The tanks can be equipped with DN 600 access dome instead of DN 400.



Additional connections not for tanks with general technical approval.

PE Secondary containment dikes



PE catch basins

Z-40.22-152

Article no.	Description	Dimensions mm (L x W x H)	Weight
930074	PE-W 2000	2,500 x 1,350 x 760	130 kg
930075	PE-W 2500	2,500 x 1,600 x 760	145 kg
930076	PE-W 3000	2,600 x 1,600 x 910	225 kg
930077	PE-W 4000	3,085 x 1,685 x 1010	265 kg



Secondary containment dikes can also be manufactured with intermediate dimensions within the scope of the approval.

The item number leads to the admission and extensive media list.

Our plastic workshop will construct your individual container for you

When the requirements go beyond the serial production: Customized round tanks and rectangular tanks made of HD-PE.

Special plastic container construction rounds out Dehoust's range of products and services: Plastic catch basins with test marks and customer-specific rectangular and round tanks are made of PE sheets. Modern production facilities and welding processes, together with certified welders and experienced employees ensure consistent high quality. We work together closely with the SKZ Würzburg and the SLV Mannheim.



Plastic storage tanks

Also suitable for drinking water installations



AQF 750 and 1000

PE storage tanks for drinking water and process water

AQF series plastic storage tanks are made of high quality polyethylene. The blue coloring makes them ideally suited for the storage of drinking water and process water. The formation of algae is prevented over the long term.

The tanks are equipped as standard with a top cover 240 mm and 2 screw connections 2" or a cover 540 mm. A lower connection S 56x4 can be used for mounting drain cocks or for the lower connection line.

PE storage tanks AQF 750 and 1000 with single bottom connection

Article no.	Description	Dimensions mm (L x W x H)	Weight kg
61176	AQF 750 with cover 240 mm and 2 screw connections 2"	720 x 720 x 1,720	24
61196	AQF 1000 with cover 240 mm and 2 screw connections 2"	780 x 780 x 2,000	30



AQF in size 570 and 690 with wide neck



AQF 570 and 690 with hand hole

PE tank AQF wide neck and two lower connections

Article no.	Description	Dimensions mm (L x W x H)	Weight kg
61200	AQF 570 with upper opening 540 mm	720 x 720 x 1,420	19
61210	AQF 690 with upper opening 540 mm	720 x 720 x 1,695	23

PE storage tanks AQF 570 and 690 with single bottom connection

Article no.	Description	Dimensions mm (L x W x H)	Weight kg
61206	AQF 570 with cover 240 mm and 2 screw connections 2"	720 x 720 x 1,430	19
61216	AQF 690 with cover 240 mm and 2 screw connections 2"	720 x 720 x 1,700	23

PE storage tanks – type AQF

Accessories battery set-up

The lower connection line creates flexible and easy to install tank systems.



Article no.	Description
971765	Basic package connecting pipe DN 50 for 2 tanks AQF with 2 taps 1 1/2"
971770	Extension for connecting further AQF with single tap 1 1/2"
71645	Stopcock 2" for shutting off the connecting line DN 50



971765 AQF connecting pipe DN 50

When using a bottom connection, ensure sufficient ventilation.



AQF 1500 and 1100

PE storage tanks AQF 1100 and 1500 with bottom connection 1 1/2"

Article no.	Description	Dimensions mm (L x W x H)	Weight kg
61280	AQF 1100 with cover 240 mm and 3 screw connections 2"	1,530 x 760 x 1,350	38
61290	AQF 1500 with cover 240 mm and 3 screw connections 2"	1,530 x 760 x 1,730	48



971755 AQF connecting pipe DN 25



Article no.	Description
971755	Basic package connecting pipe DN 25 for 2 tanks AQF
971760	Extension to connect further AQF
71681	Stopcock 1"/DN 25 for shutting off the connecting line

AQF tanks are available in black and customized in special colors

Single-walled and double-walled plastic tanks with approval (DIBt)

Storage tanks made of polyethylene (HD-PE) are suitable for the storage of a range of different liquids. The media mentioned in the general building approvals of the DIBt represent only a portion of the possible applications. We would be happy to advise you if you have special requirements.

Below you can see the plastic storage tanks up to 4,000 liters in single-wall design for installation in catch basins or construction site catch basins.

The double-walled tanks of the TrioSafe and PE Kombi series offer the double safety required for the storage of water-polluting liquids. This means no secondary containment on site required.



Our products:

- ▶ Single-walled storage tanks PE DF
- ▶ Double walled storage and collection tanks
- ▶ Double-walled fuel oil tanks TrioSafe and PE Kombi

2in1

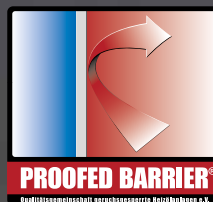

**JUST A FEW EASY STEPS AND
YOU CAN BE INDEPENDENT FROM
SUPPLY AND PRICE FLUCTUATIONS**



4

Plastic storage tanks

Plastic tanks for fresh and used oils, coolant ethylene glycol and concrete admixtures



Wide range of uses and applications

Plastic storage tanks are made of HD-PE using the blow molding method. They are an inexpensive solution when it comes to storing liquids that are hazardous to water.

The general technical approval specifies the media permitted in individual tanks. For more information, please enter the item number in the search box on the website.

The required secondary protection is provided by our secondary containment dikes which are approved by DIBt and water law, or by a catch basin provided by the customer.

PE storage tanks with galvanized steel banding, dome DN 400, Z-40.21-138



Article no.	Description	Dimensions mm (L x W x H)	Weight
971253	PE 2000 D	2,070 x 720 x 1,690	110 kg
971605	PE 2500 D	1,870 x 995 x 1,650	115 kg
971593	PE 3000 D	2,230 x 995 x 1,650	165 kg
971589	PE 4000 D	2,430 x 995 x 1,950	235 kg



Concrete admixtures and mortar admixtures

Concrete admixtures are water hazard category 1 liquids and may only be stored in approved containers.

The DIBt confirms the suitability of the PE storage tanks for the current concrete admixtures with the substance list in the DIBt approval 40.21-138.

The Triosafe storage tanks with integrated catch basins are also approved for concrete admixtures.



AdBlue® Storage tanks

Plastic containers and PE catch basins for AdBlue® and used photographic chemicals



PE storage tanks with coated reinforcements

Z-40.21-138

Article no.	Description	Dimensions mm (L x W x H)	Weight
971293	PE 1100 D KB	1,400 x 720 x 1,400	55 kg
971597	PE 2000 D KB	2,070 x 720 x 1,690	110 kg
971596	PE 2500 D KB	1,870 x 995 x 1,650	115 kg
971595	PE 3000 D KB	2,230 x 995 x 1,650	165 kg
971590	PE 4000 D KB	2,430 x 995 x 1,950	235 kg



PE Secondary containment dikes for AdBlue® tanks

Z-40.22-152

Article no.	Description	Dimensions mm (L x W x H)	Weight
930105	PE-W 2000 AdBlue®	2,470 x 1,120 x 1,360	255 kg
930097	PE-W 2500 AdBlue®	2,250 x 1,400 x 1,360	270 kg
930098	PE-W 3000 AdBlue®	2,600 x 1,400 x 1,360	290 kg
930099	PE-W 4000 AdBlue®	2,800 x 1,400 x 1,610	325 kg

further secondary containment dikes on page 59



Plastic storage tanks are the basis for AdBlue® stations from various manufacturers. The outstanding features are constantly opening up new areas of application.

The Triosafe storage tanks with integrated secondary containment dikes are also approved for AdBlue®.

For underground installation and for larger storage quantities, we supply double-walled tanks made of steel/stainless steel – more on page 19.

Plastic diesel tanks

Double-walled – with secondary containment dike, easy to set up



For the independent, secure supply of industry and commerce, agriculture, fire and rescue services



PE Kombi storage and collection tanks

One tank system with a lot of advantages:

- ▶ Compact design with accessible, ventilated console
- ▶ Inner tank made of high-quality polyethylene (HD-PE)
- ▶ Water-law and building-law approval from the DIBt Z-40.21-53
- ▶ Integrated secondary containment dike made of galvanized sheet steel on both sides, tightly welded without additional seals
- ▶ Visual leakage indicator and content indicator as well as venting hood as standard equipment
- ▶ Installation also in earthquake-prone areas

TANKS WITH INTEGRATED CATCH BASIN, SECONDARY PROTECTION AS STANDARD



Product example:

Diesel tank unit PE Kombi complete with electric pump

Article no.	961361	961360
Length	1100 mm	1100 mm
Width	700 mm	700 mm
Height with pump	1850 mm	1500 mm
Contents	1000 l	720 l
Pump output	32 l/min	32 l/min



PE Kombi diesel tanks and battery accessories at a glance

Article no.	Description	Dimensions mm (L x W x H)	Weight
961301	PE Combi 720 VS	1100 x 700 x 1200	68 kg
961302	PE Combi 1000 VS	1100 x 700 x 1600	84 kg

Diesel tank batteries (upper filling and extraction system)	
952450	Main package PE Kombi diesel DE-A-01 for the first tank
952451	Extension package PE Kombi diesel DE-A-01 for each additional tank

Product example 2 series diesel battery: 2x 961301, 1x 962450 und 1x 962451

Storage and collection tanks

Storage tanks from Dehoust with integrated secondary containment dikes provide sufficient storage volume for the storage of operating materials such as diesel, engine and hydraulic oils in individual tanks and diesel tank systems up to 5,000 liters.

Dehoust storage tanks are made of high quality polyethylene (HD-PE), which for decades has proven its effectiveness in the storage of heating oil and diesel fuel, motor oil and many other chemicals. The PE Kombi tank and TrioSafe container systems are supplied with an integrated catch basin which eliminates the need for additional secondary protection or catch systems.

The systems have a general building code approval from DIBt and are easy to install in buildings. Pumps for the various applications complete the range.

Storage tanks for fresh oils, hydraulic oils, engine oils

The various pumps are ideally mounted on a console (910194). You can find a large selection of pumps in our data sheets.

Article no.	Description	Dimensions mm (L x W)	Height with pump
961380	Fresh oil tank 720 with pump	1,100 x 700	1,450/1,600
961381	Fresh oil tank 1000 with pump	1,100 x 700	1,850/2,000



PE Kombi storage and collection tanks – the ideal waste oil collection tank

PE Kombi tanks are expressly approved for the storage of fresh and used mineral oils (oils of known origin). The lockable waste oil funnel makes the storage of used engine and hydraulic oils simple and safe. The lockable hopper guarantees that the container is only used by qualified personnel.

Article no.	Description	Dimensions mm (L x W)
961370	Waste oil collection tank Kombi 720	1,100 x 700 x 1,400
961371	Waste oil collection tank Kombi 1000	1,100 x 700 x 1,800



Pilot Project University Police Baden-Württemberg in Biberach ©DUC KEK Ulm

Day tank and storage tank for emergency power systems

More connection options for measuring and control equipment with adapter sets

Tanks for emergency power systems, lubricating oil storage tanks for CHP units and other machines as well as day tanks place higher demands on measurement and control equipment.

With our adapter set and special combinations, we take this into account and enable the use of the PE Kombi tanks and TrioSafe tanks for use as day tanks and storage tanks.



Article no.	Description	Dimensions mm (L x W x H)
961385	Day tank 720 with basin	1,100 x 700 x 1,300
961386	Day tank 1000 with basin	1,100 x 700 x 1,700

Storage tanks

Plastic storage tanks with cleaning opening Z-40.21-310



Double-walled plastic storage tanks with cleaning opening

Article no.	Description	Dimensions mm (L x W x H with pump)
961509	Storage tank TrioSafe 750 with cleaning opening	780 x 780 x 1.710
961515	Storage tank TrioSafe 1000 with cleaning opening	810 x 810 x 1.990
961546	Storage tank TrioSafe 1100 with cleaning opening	1.580 x 780 x 1.360
961536	Storage tank TrioSafe 1500 with cleaning opening	1.580 x 780 x 1.740

Approved media according to abZ

1. Heating oil EL in accordance with DIN 51603-17,
2. Heating oil DIN 51603 - 6 EL A Bio 5 to Bio 15 in accordance with DIN SPEC 51603-68 with addition of FAME in accordance with DIN EN 142149; no additional alternative components,
3. Diesel fuel in accordance with DIN EN ISO 59010,
4. Fatty acid methylester in accordance with DIN EN 142149 (biodiesel),
5. Lubricating, hydraulic, heat transfer oils Q, alloyed or unalloyed, burning point > 55 °C,
6. Lubricating, hydraulic, heat transfer oils Q, used, burning point > 55 °C
7. Vegetable oils such as cottonseed, olive, canola, castor, or wheat germ oil in any concentration that is not used as food or for the production of food products,
8. Ethylene glycol (CH₂OH) used as an antifreeze for radiators,
9. Photographic chemicals (commercially available) in use concentration (new and used) with a density of max. 1.15 g/cm,
10. Ammonia water (solution) NH₃OH, to the saturated solution,
11. Pure urea solution 32.5% used as NO_x reducing agent (e.g. AdBlue®) in accordance with DIN 7007011, with a density of max. 1.15 g/cm³,
12. Concrete admixtures in accordance with DIN EN 934-212 with a density of max. 1.15 g/cm³



No.9-12 not in combi tanks; the following provisions apply the abZ; in practice, PE containers have proven themselves effective for the storage of a broad range of media

2in1

Storage tank TrioSafe 750 to 1500 Z40.21 310



Article no.	Description	Dimensions mm (L x W x H with pump)
961503	Storage tank TrioSafe 750	780 x 780 x 1,710
961541	Storage tank TrioSafe 1100	1,580 x 790 x 1,360
961523	Storage tank TrioSafe 1500	1,580 x 790 x 1,740
961370	Collection tank 720 with waste oil funnel	1,100 x 700 x 1,400
961371	Collection tank 1000 with waste oil funnel and step	1,100 x 700 x 1,800

The right solution for whatever you need ...

... and catch basin included!

The TrioSafe tanks are storage tank and secondary containment in one. It could not be easier to ensure safety when it comes to storing water-hazardous substances, such as concrete admixtures, AdBlue® or even diesel fuels and oils.



Double-walled diesel tank system and day tank

Article no.	Description	Dimensions mm (L x W x H with pump)
961570	Diesel tank unit TrioSafe 1500 VS complete with electric pump	1,580 x 790 x 2,000
961585	Storage tank TrioSafe 1500 VS	1,580 x 790 x 2,000



TrioSafe Plus – double-walled heating oil tanks

750 to 9,000 liters total volume

Sealed tight: with proven odor barrier



Product advantages:

- ▶ Corrosion-free inner tank made of HD-PE, seamlessly blown
- ▶ Additional diffusion barrier PE Plus with regular review by the Fraunhofer Institute
- ▶ Secondary protection tested for leak resistance as standard – thus space-saving set-up
- ▶ Variable installation up to 6 containers of one size
- ▶ DE-A-01 safety accessories for safe filling and operation
- ▶ Tank content indicator
- ▶ Translucent outer wall eliminates the need for a leak detection system



Dimensions TrioSafe 750/1000

Z-40.21-310

Article no.	Description	Length	Width	Height	Weight
961501	TrioSafe 750 Plus	780 mm	780 mm	1,710 mm	44 kg
961510	TrioSafe 1000 Plus	810 mm	810 mm	1,990 mm	56 kg

Dimensions TrioSafe 1100/1500

Z-40.21-310

Article no.	Description	Length	Width	Height	Weight
961540	TrioSafe 1100 Plus	1,580 mm	790 mm	1,360 mm	62 kg
961520	TrioSafe 1500 Plus	1,580 mm	790 mm	1,740 mm	76 kg



2in1

TrioSafe doubly safe with its PE-Plus inner tank and integrated secondary containment dike.



TrioSafe series heating oil tanks and storage tanks provide double safety:

Inner tank and outer tank are seamlessly blown from one piece and as a unit for the storage of various water-hazardous liquids with the general building inspection approval of the DIBt. Z-40.21-310 approved The liner complies with EN 13341.

More information on the wide range of applications for double-walled plastic tanks is available in our videos:



Innovative storage systems

FOR SAFE HEATING OIL STORAGE
WITHOUT THE ANNOYING ODOR

TANK ADVANTAGES

Mechanical content indicator for each tank

Leakage detection

Permanent secondary protection with the secondary containment dike

Protection of the filling material (bio, heating oil and e-fuels) from aging due to light exposure

Handles make transport easy

Corrosion-free PE tank with additional diffusion barrier PE-PLUS

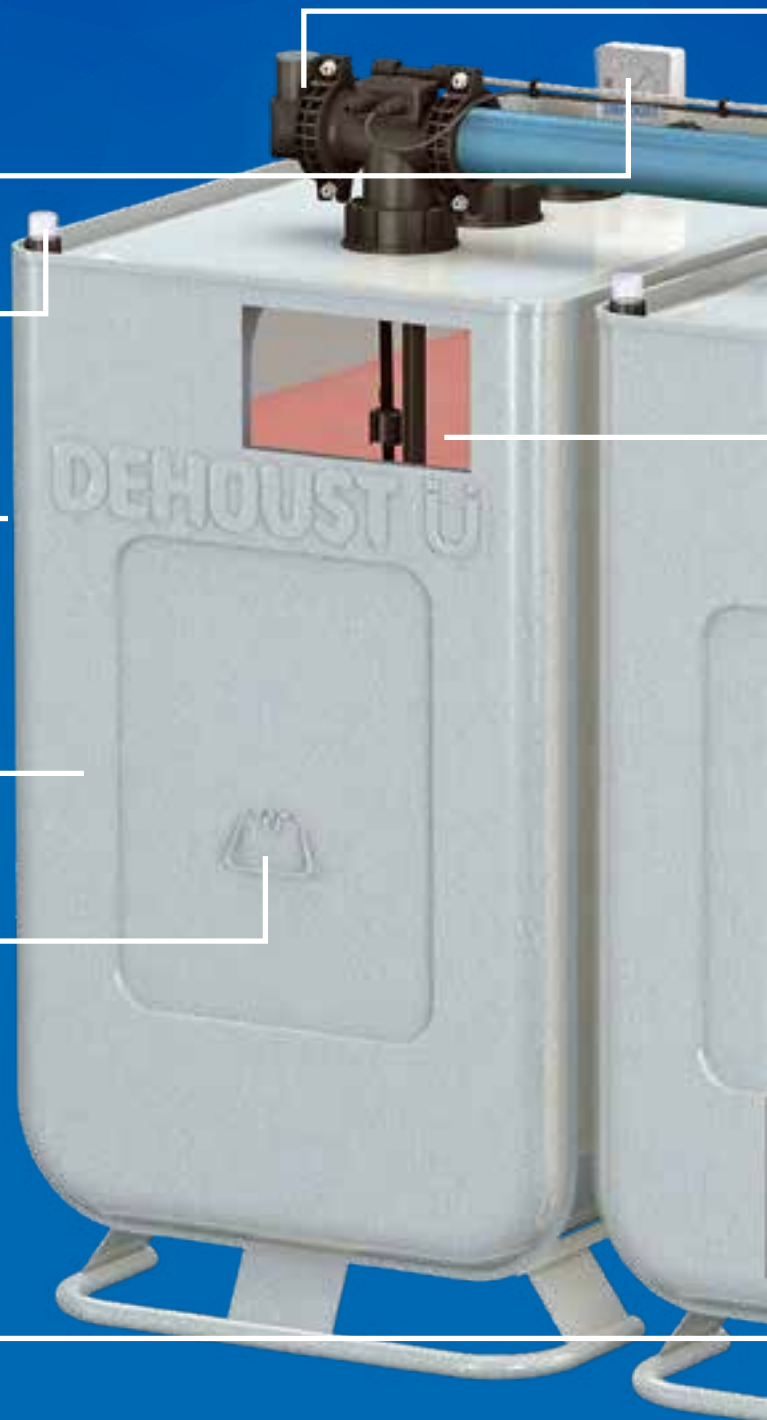

Dimensions PE Kombi 720/1000

Z-40.21-53

Article no.	Description	Length	Width	Height	Weight
961201	PE Kombi 720 PLUS	1,100 mm	700 mm	1,200 mm	68 kg
961202	PE Kombi 1000 PLUS	1,100 mm	700 mm	1,600 mm	84 kg



EN 13341

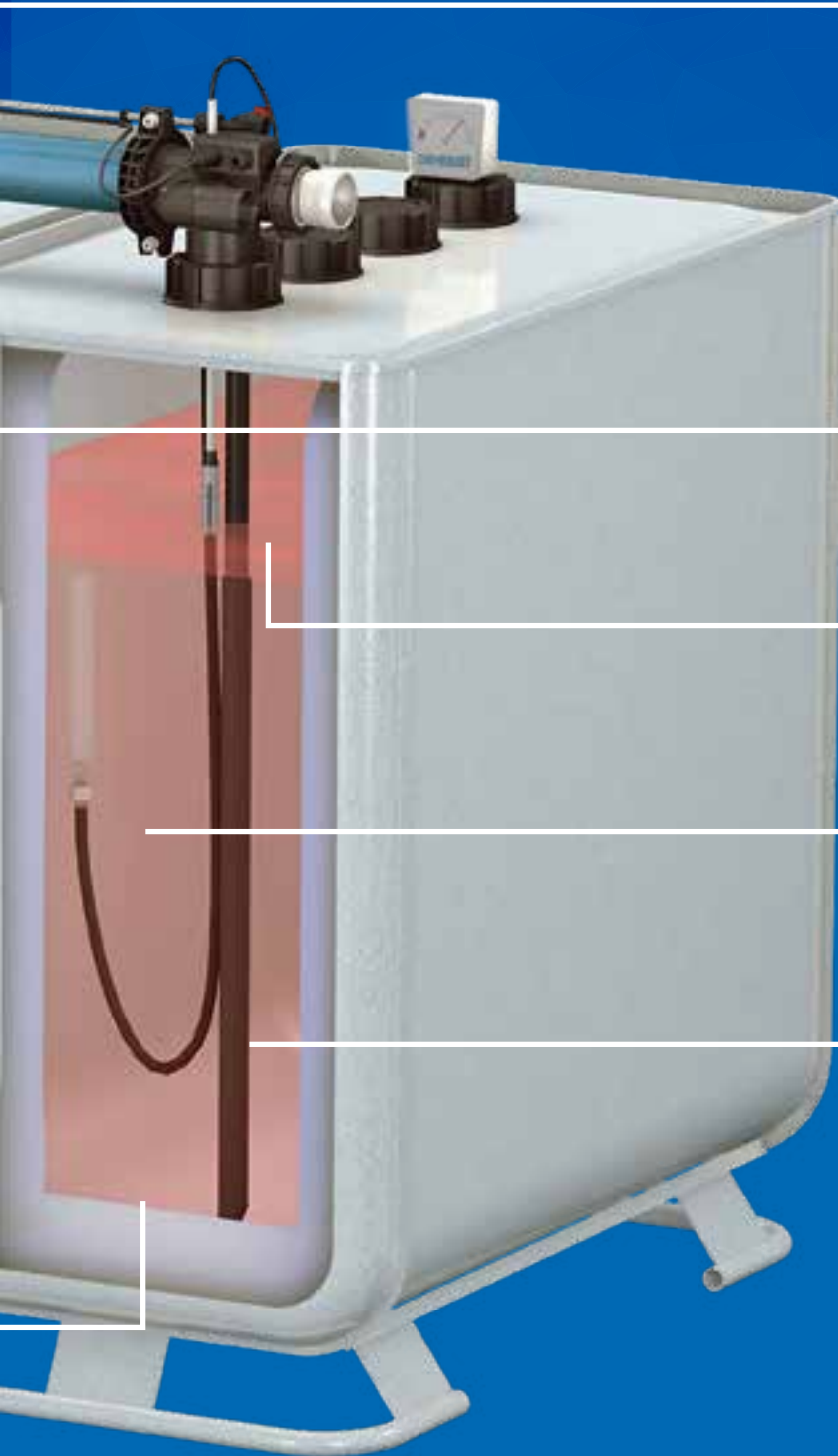

DE-A-01

Ventilation can be installed on either the first or last tank

The GWG chain monitors each tank during filling

Limit switch with metal sleeve

Floating extraction

Telescopic foam pipe for all tank sizes

Safety accessories with GWG chain



DE-A-01

Our Industry Service:

For better products and cutting demand peaks

Our off-line fluorination chambers of max. 20 m³ can meet peak demands in a short lead time and guarantee a high standard of quality.

Blow moulding machines with accumulator head from 5 liters to 180 liters in mono and multi-layer versions allow us to manufacture a wide range of products economically, including small batches.

Injection moulding machines for small batch sizes up to 1500 KN are also available.



Blow moulding machine



Off-line fluorination

DEHOUST GmbH

Gutenbergstraße 5-7, 69181 Leimen, Germany, Phone +49 62 24 / 97 02-0, info@dehoust.de, www.dehoust.com

The information in this publication is subject to change. We reserve the right to make technical changes without prior notice. Performance specifications are non-binding; a guaranteed feature cannot be derived from them. The terms and conditions agreed with our order confirmation shall apply exclusively. The country-specific approvals and installation regulations must be complied with.

Leimen in July 2023

